



Intertek



- Heating mats
- Foil mats
- In-screed cables
- Loose laid cables
- Insulation boards
- Accessories & adhesives
- Thermostats
- Frost protection
- Mirror demisters
- Electric heaters



- Best price, best value
- Free next day delivery
- Lifetime warranty
- All mats are S Mark approved

Electric underfloor heating  
**PRICELIST 2022**

**01473 276677**

[www.elementsunderfloorheating.co.uk](http://www.elementsunderfloorheating.co.uk)



## elements underfloor heating ticks all the boxes

The new **elements** underfloor heating range offers premium specifications at unbeatable value and the superior product design ensures a quick, hassle-free, top quality installation.

**Available from all good electric wholesalers.  
Call us on 01473 276677 to find out more.**

## Contents

eMat Pro	4
eFoil	10
eFlex	12
eCable	14
ePanel Boards	16
XPS Insulation Boards	17
Decoupling Matting	18
Accessories	19
Adhesives, Levellers & Primers	20
Thermostats	21
Pre-made Trace Heating Kits	25
eDemist Heating Pads	26
Heating Design Service	28
Radiator Sizing Charts	29
Harmoni Electric Radiators	30
Harmoni Electric Towel Rails	37
Harmoni App	38
Harmoni Remote Controller	39



## Customer service

**elements** is different to many underfloor heating manufacturers in that we are a service oriented company. It's our goal to ensure that your purchase is based on an educated decision and our dedication to customer satisfaction means we aim to exceed your expectations.

From the start of your project we'll offer a solution backed by expert advice and support. Add in our generous product warranties and you're guaranteed complete satisfaction every step of the way.



## Technical support

Our in-house advisors have a wealth of practical experience and can provide expert assistance with all aspects of underfloor heating – from installation methods to floor structures and coverings – throughout the entire project.



Call our technical helpline on 01473 559070



## Free design service

We offer a free electric underfloor heating design service and can guide you through the process. Alternatively, send us a drawing or plan and we'll produce a free fully-detailed quotation. For more information, see page 28.

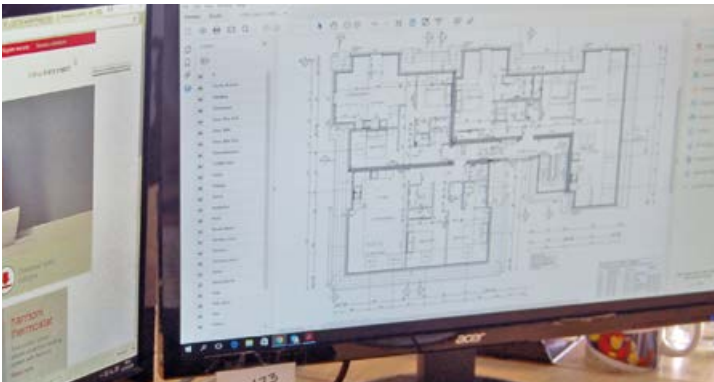
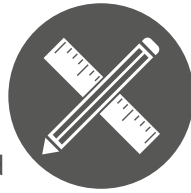

## Quality & experience

Quality matters to us. That's why each of our underfloor heating products is designed and manufactured to our own premium specifications, ensuring that every **elements** underfloor heating solution meets the demands of your application.

Backed up by more than 20 years' experience we have the know-how to bring you the best range of robust, reliable and durable electric underfloor heating products with enhanced features that make installations quicker and easier.

Together with our unrivalled customer service and generous warranties, we're confident that **elements** ticks all the boxes.

## The elements difference



- Best price, best value
- Free next day delivery
- Lifetime warranty
- Best quality S Mark approved

## Approved & tested to the highest standards

Our underfloor heating products conform to the requirements of the relevant European Directives.

They are also independently Intertek S Mark and SGS Fimko FI mark approved, visual proof that they are manufactured to the highest standards in safety and added assurance that there is no risk of a product safety failure.



Intertek

## Generous warranties

For added peace of mind all of the **elements** products come with generous warranties, including a lifetime warranty on eMat, eFoil, eFlex and eCable\*.

\*Conditions apply: see website for details.



## Contact us to find out more

01473 276677

sales@elementsunderfloorheating.co.uk

# eMat Pro 100

FOR TIMBER BASED FLOORS

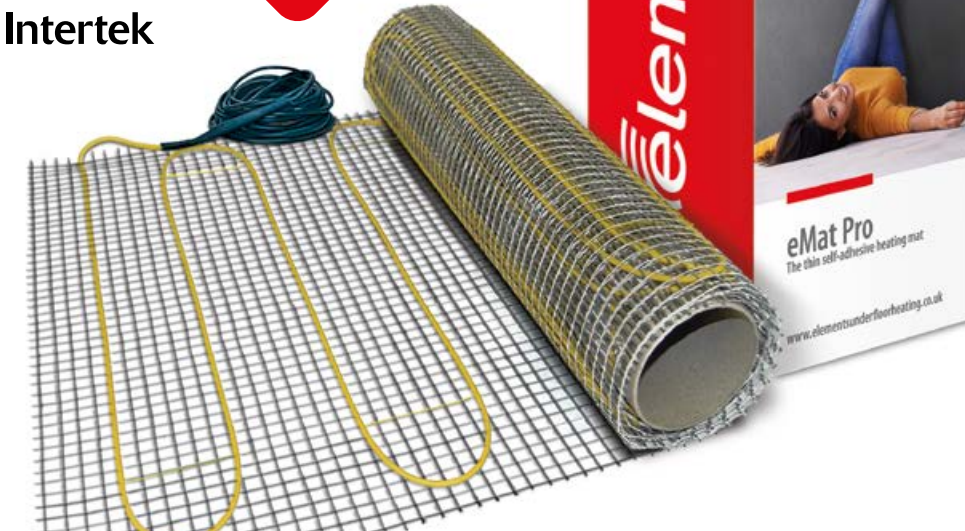

Download a PDF datasheet

The eMat underfloor heating mat has a self-adhesive fibreglass backing mesh with a pre-attached ultra-thin twin conductor 3mm heating cable, ensuring minimal increase to the existing floor height.

Superior product design ensures a speedy installation whilst allowing unlimited adjustment of the heating element to suit irregular formats.

Once installed, the mat will emit an even, comfortable warmth across the entire floor surface.

## Features

- Self-adhesive mesh
- Ultra-thin heating cable
- Twin conductor heating cable
- Suitable for most floor surfaces
- 100% aluminium earth sheath

## Specification

Cable thickness	3mm
Output	100W/m <sup>2</sup>
Operating voltage	230/240V
Cold tail connection lead	3m

## Application

The eMat Pro 100 can be installed under ceramic, porcelain, slate and natural stone tiles. When using laminate, engineered timber or vinyl floors, a self-levelling compound should be used.

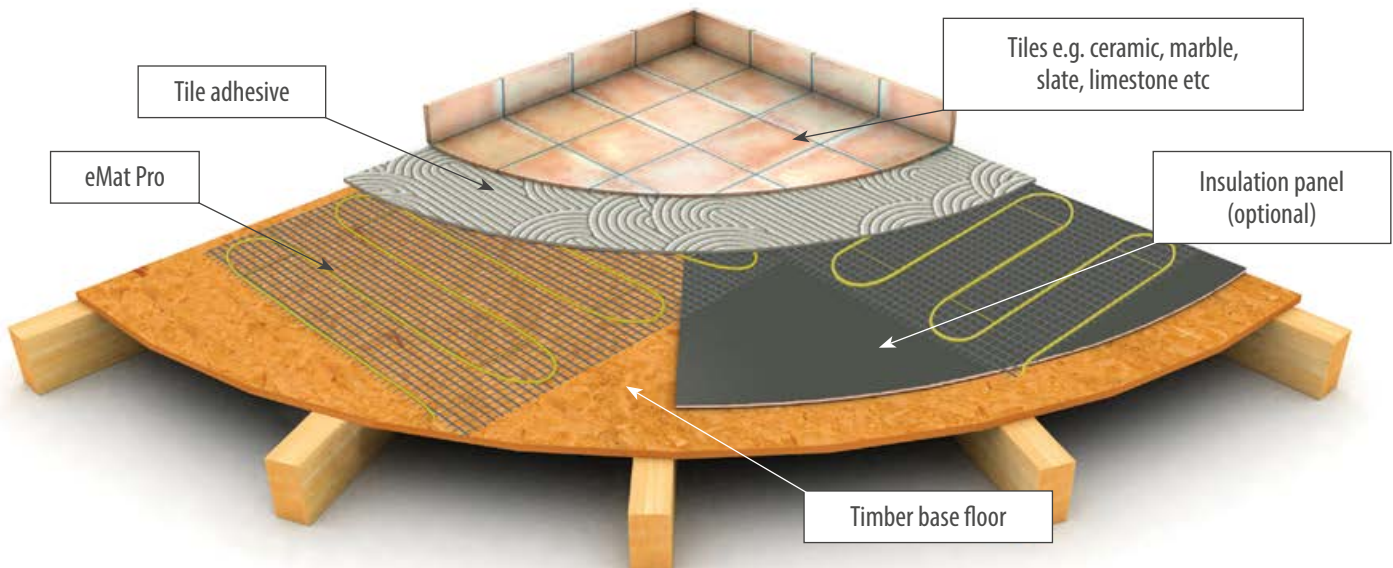

## eMat Pro 100 Mat

Select the eMat to suit your room coverage. To make a full kit add a thermostat and a fixing kit.

Q/F	Part Code	Dimensions	Coverage	Wattage	Mat Length	List Price
13322	eMat100-0.5	0.5m × 1m	0.5m <sup>2</sup>	50w	1m	£52.93
11173	eMat100-1.0	0.5m × 2m	1.0m <sup>2</sup>	100w	2m	£55.91
11174	eMat100-1.5	0.5m × 3m	1.5m <sup>2</sup>	150w	3m	£69.09
11175	eMat100-2.0	0.5m × 4m	2.0m <sup>2</sup>	200w	4m	£83.18
11176	eMat100-2.5	0.5m × 5m	2.5m <sup>2</sup>	250w	5m	£97.73
11177	eMat100-3.0	0.5m × 6m	3.0m <sup>2</sup>	300w	6m	£110.91
11178	eMat100-3.5	0.5m × 7m	3.5m <sup>2</sup>	350w	7m	£124.09
11179	eMat100-4.0	0.5m × 8m	4.0m <sup>2</sup>	400w	8m	£138.18
11180	eMat100-5.0	0.5m × 10m	5.0m <sup>2</sup>	500w	10m	£164.55
11181	eMat100-6.0	0.5m × 12m	6.0m <sup>2</sup>	600w	12m	£187.60
11182	eMat100-7.0	0.5m × 14m	7.0m <sup>2</sup>	700w	14m	£209.00
11183	eMat100-8.0	0.5m × 16m	8.0m <sup>2</sup>	800w	16m	£234.80
11184	eMat100-9.0	0.5m × 18m	9.0m <sup>2</sup>	900w	18m	£259.65
11185	eMat100-10.0	0.5m × 20m	10.0m <sup>2</sup>	1000w	20m	£285.50
11186	eMat100-12.0	0.5m × 24m	12.0m <sup>2</sup>	1200w	24m	£339.00

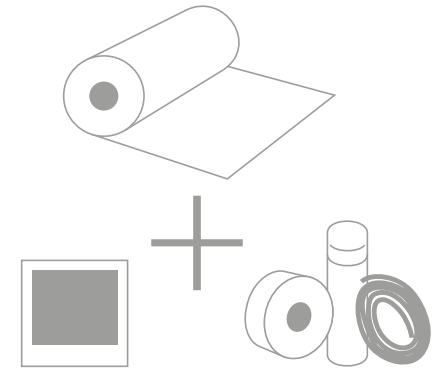

### Mat Fixing Kit

- 1 × Superspray adhesive for matting (500ml)
- 1 × Single sided utility duct tape (50m)
- 1 × Flexible conduit for floor sensing thermostat per metre

Q/F	List Price
17667	£9.97

## Thermostats SEE FULL LIST ON PAGE 21

Q/F	Part Code	Description	Room	Floor	Switching Capacity	List Price
16435	HTP100	Harmoni 100+ Wi-Fi touch screen 7-day programmable thermostat	Yes	Yes	3680W@230V	£165.38
16434	HT100	Harmoni 100 Touch screen 7-day programmable thermostat	Yes	Yes	3680W@230V	£114.00
8298	140G0052	Harmoni 25 Digital timer 7-day programmable thermostat	Yes	Yes	2990W @ 230V	£61.70
760	eStat760	eStat 760 Switchable manual non-programmable thermostat	Yes	Yes	3450W @ 230V	£49.95
763	eStat763	eStat 763 Switchable sensing 7-day programmable thermostat	Yes	Yes	3450W @ 230V	£79.95
13741	088L0121	Danfoss ECTemp Plus electric floor heating room thermostat	Yes	Yes	3680 W @ 230 V	£84.00
12133	140F1140	DEVreg Smart programmable thermostat – Polar white (also available in black)	Yes	Yes	3680W @ 230V	£130.57
13260	1244-013810	Raychem Green Leaf touch screen programmable thermostat	Yes	Yes	3000W @ 230V	£79.91

All prices shown are exclusive of VAT

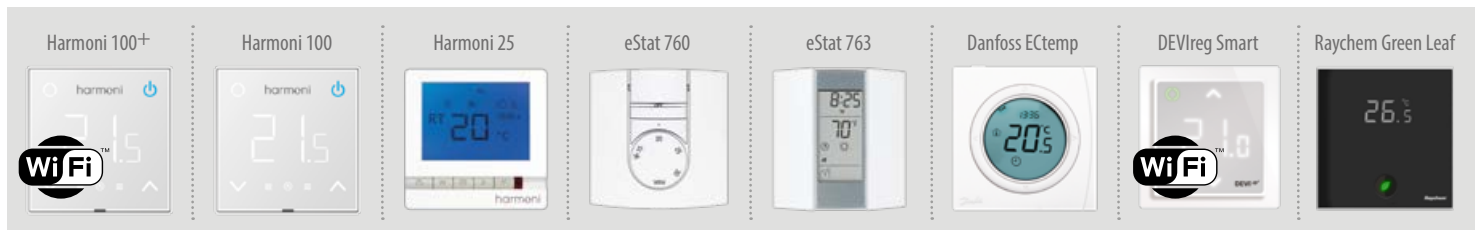

Best Price Guarantee



FREE Next Day Delivery



FREE Design Service



Smart Customer Service



Expert Technical Advice

# eMat Pro 150

FOR CONCRETE BASED FLOORS



Intertek

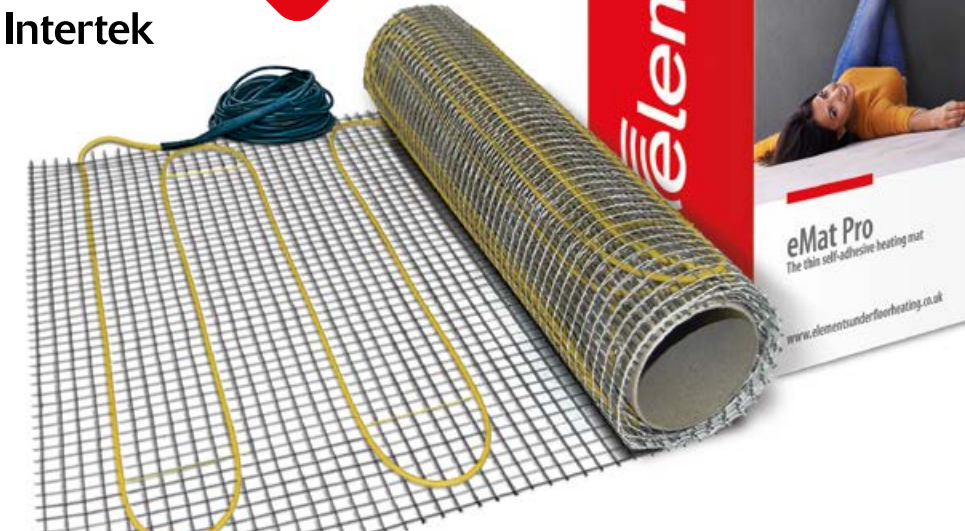

Download a PDF datasheet

The eMat underfloor heating mat has a self-adhesive fibreglass backing mesh with a pre-attached ultra-thin twin conductor 3mm heating cable, ensuring minimal increase to the existing floor height.

Superior product design ensures a speedy installation whilst allowing unlimited adjustment of the heating element to suit irregular formats.

Once installed, the mat will emit an even, comfortable warmth across the entire floor surface.

## Features

- Self-adhesive mesh
- Ultra-thin heating cable
- Twin conductor heating cable
- Suitable for most floor surfaces
- 100% aluminium earth sheath

## Specification

Cable thickness	3mm
Output	150W/m <sup>2</sup>
Operating voltage	230/240V
Cold tail connection lead	3m

## Application

The eMat Pro 150 can be installed under ceramic, porcelain, slate and natural stone tiles. When using laminate, engineered timber or vinyl floors, a self-levelling compound should be used.

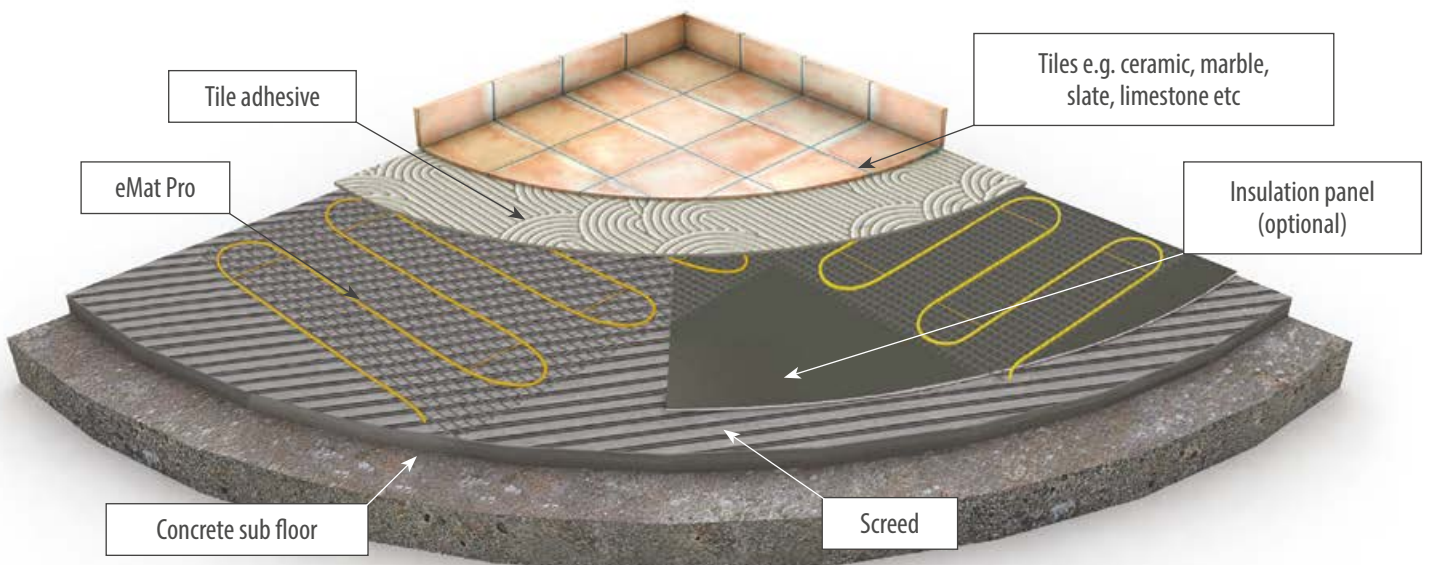

## eMat Pro 150 Mat

Select the eMat to suit your room coverage. To make a full kit add a thermostat and a fixing kit.

Q/F	Part Code	Dimensions	Coverage	Wattage	Mat Length	List Price
13324	eMat150-0.5	0.5m × 1m	0.5m <sup>2</sup>	75w	1m	£52.93
11188	eMat150-1.0	0.5m × 2m	1.0m <sup>2</sup>	150w	2m	£55.91
11189	eMat150-1.5	0.5m × 3m	1.5m <sup>2</sup>	225w	3m	£69.09
11190	eMat150-2.0	0.5m × 4m	2.0m <sup>2</sup>	300w	4m	£83.18
11191	eMat150-2.5	0.5m × 5m	2.5m <sup>2</sup>	375w	5m	£97.73
11192	eMat150-3.0	0.5m × 6m	3.0m <sup>2</sup>	450w	6m	£110.91
11193	eMat150-3.5	0.5m × 7m	3.5m <sup>2</sup>	525w	7m	£124.09
11194	eMat150-4.0	0.5m × 8m	4.0m <sup>2</sup>	600w	8m	£138.18
11195	eMat150-5.0	0.5m × 10m	5.0m <sup>2</sup>	750w	10m	£164.55
11196	eMat150-6.0	0.5m × 12m	6.0m <sup>2</sup>	900w	12m	£187.60
11197	eMat150-7.0	0.5m × 14m	7.0m <sup>2</sup>	1050w	14m	£209.00
11198	eMat150-8.0	0.5m × 16m	8.0m <sup>2</sup>	1200w	16m	£234.80
11199	eMat150-9.0	0.5m × 18m	9.0m <sup>2</sup>	1350w	18m	£259.65
11200	eMat150-10.0	0.5m × 20m	10.0m <sup>2</sup>	1500w	20m	£285.50
11201	eMat150-12.0	0.5m × 24m	12.0m <sup>2</sup>	1800w	24m	£339.00

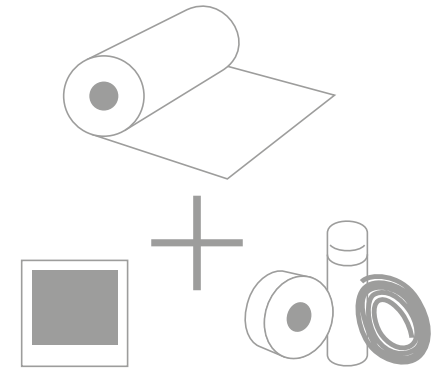

### Mat Fixing Kit

- 1 × Superspray adhesive for matting (500ml)
- 1 × Single sided utility duct tape (50m)
- 1 × Flexible conduit for floor sensing thermostat per metre

Q/F	List Price
17667	£9.97

## Thermostats SEE FULL LIST ON PAGE 21

Q/F	Part Code	Description	Room	Floor	Switching Capacity	List Price
16435	HTP100	Harmoni 100+ Wi-Fi touch screen 7-day programmable thermostat	Yes	Yes	3680W@230V	£165.38
16434	HT100	Harmoni 100 Touch screen 7-day programmable thermostat	Yes	Yes	3680W@230V	£114.00
8298	140G0052	Harmoni 25 Digital timer 7-day programmable thermostat	Yes	Yes	2990W @ 230V	£61.70
760	eStat760	eStat 760 Switchable manual non-programmable thermostat	Yes	Yes	3450W @ 230V	£49.95
763	eStat763	eStat 763 Switchable sensing 7-day programmable thermostat	Yes	Yes	3450W @ 230V	£79.95
13741	088L0121	Danfoss ECTemp Plus electric floor heating room thermostat	Yes	Yes	3680 W @ 230 V	£84.00
12133	140F1140	DEVreg Smart programmable thermostat – Polar white (also available in black)	Yes	Yes	3680W @ 230V	£130.57
13260	1244-013810	Raychem Green Leaf touch screen programmable thermostat	Yes	Yes	3000W @ 230V	£79.91

All prices shown are exclusive of VAT



Best Price Guarantee



FREE Next Day Delivery



FREE Design Service



Smart Customer Service



Expert Technical Advice

# eMat Pro 200

FOR CONSERVATORY/HIGH OUTPUT

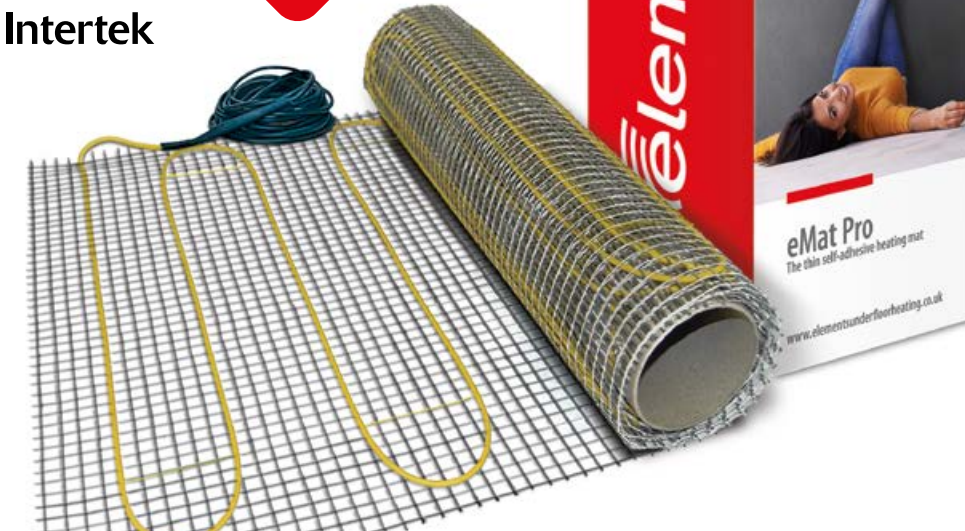

Download a PDF datasheet

The eMat underfloor heating mat has a self-adhesive fibreglass backing mesh with a pre-attached ultra-thin twin conductor 3mm heating cable, ensuring minimal increase to the existing floor height.

Superior product design ensures a speedy installation whilst allowing unlimited adjustment of the heating element to suit irregular formats.

Once installed, the mat will emit an even, comfortable warmth across the entire floor surface.

## Features

- Self-adhesive mesh
- Ultra-thin heating cable
- Twin conductor heating cable
- Suitable for most floor surfaces
- 100% aluminium earth sheath

## Specification

Cable thickness	3mm
Output	200W/m <sup>2</sup>
Operating voltage	230/240V
Cold tail connection lead	3m

## Application

The eMat Pro 200 can be installed under ceramic, porcelain, slate and natural stone tiles. When using laminate, engineered timber or vinyl floors, a self-levelling compound should be used.

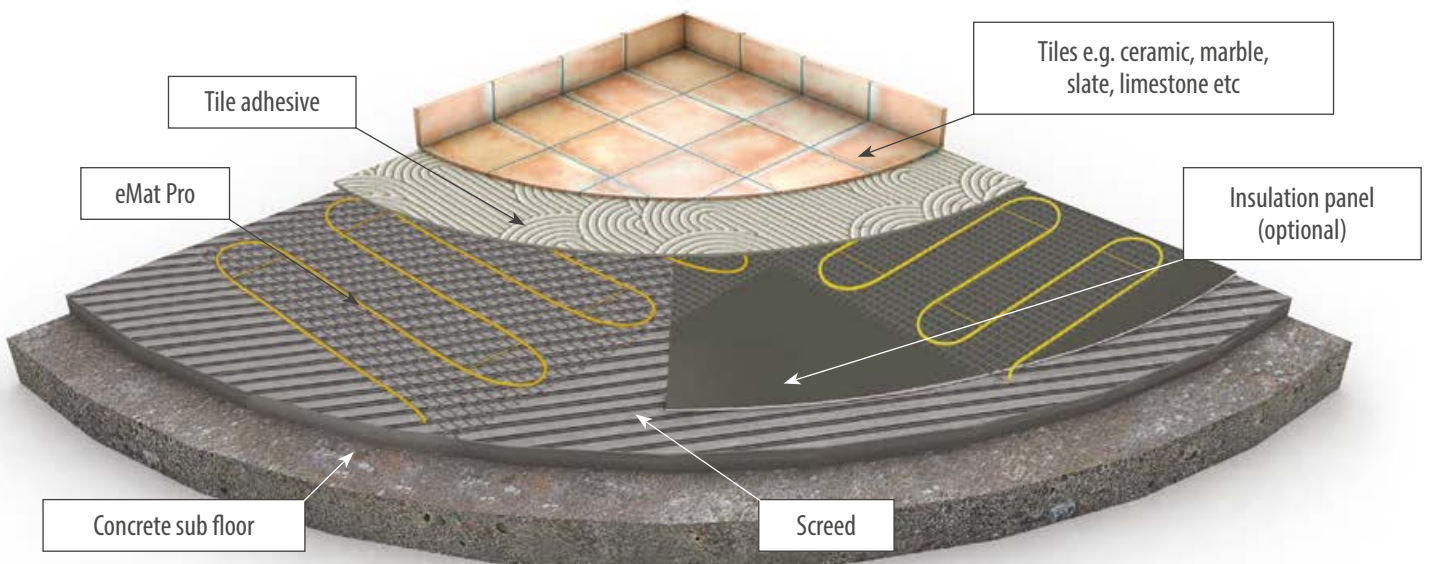



## eMat Pro 200 Mat

Select the eMat to suit your room coverage. To make a full kit add a thermostat and a fixing kit.

Q/F	Part Code	Dimensions	Coverage	Wattage	Mat Length	List Price
13326	eMat200-0.5	0.5m × 1m	0.5m <sup>2</sup>	100w	1m	£52.93
11639	eMat200-1.0	0.5m × 2m	1.0m <sup>2</sup>	200w	2m	£55.91
11640	eMat200-1.5	0.5m × 3m	1.5m <sup>2</sup>	300w	3m	£69.09
11641	eMat200-2.0	0.5m × 4m	2.0m <sup>2</sup>	400w	4m	£83.18
11642	eMat200-2.5	0.5m × 5m	2.5m <sup>2</sup>	500w	5m	£97.73
11643	eMat200-3.0	0.5m × 6m	3.0m <sup>2</sup>	600w	6m	£110.91
11644	eMat200-3.5	0.5m × 7m	3.5m <sup>2</sup>	700w	7m	£124.09
11645	eMat200-4.0	0.5m × 8m	4.0m <sup>2</sup>	800w	8m	£138.18
11646	eMat200-5.0	0.5m × 10m	5.0m <sup>2</sup>	1000w	10m	£164.55
11647	eMat200-6.0	0.5m × 12m	6.0m <sup>2</sup>	1200w	12m	£187.60
11648	eMat200-7.0	0.5m × 14m	7.0m <sup>2</sup>	1400w	14m	£209.00
11649	eMat200-8.0	0.5m × 16m	8.0m <sup>2</sup>	1600w	16m	£234.80
11650	eMat200-9.0	0.5m × 18m	9.0m <sup>2</sup>	1800w	18m	£259.65
11651	eMat200-10.0	0.5m × 20m	10.0m <sup>2</sup>	2000w	20m	£285.50
11652	eMat200-12.0	0.5m × 24m	12.0m <sup>2</sup>	2400w	24m	£339.00

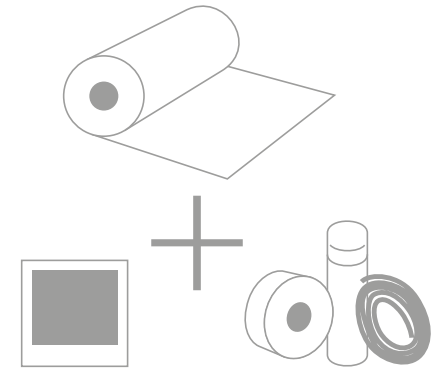

### Mat Fixing Kit

- 1 × Superspray adhesive for matting (500ml)
- 1 × Single sided utility duct tape (50m)
- 1 × Flexible conduit for floor sensing thermostat per metre

Q/F	List Price
17667	£9.97

## Thermostats SEE FULL LIST ON PAGE 21

Q/F	Part Code	Description	Room	Floor	Switching Capacity	List Price
16435	HTP100	Harmoni 100+ Wi-Fi touch screen 7-day programmable thermostat	Yes	Yes	3680W@230V	£165.38
16434	HT100	Harmoni 100 Touch screen 7-day programmable thermostat	Yes	Yes	3680W@230V	£114.00
8298	140G0052	Harmoni 25 Digital timer 7-day programmable thermostat	Yes	Yes	2990W @ 230V	£61.70
760	eStat760	eStat 760 Switchable manual non-programmable thermostat	Yes	Yes	3450W @ 230V	£49.95
763	eStat763	eStat 763 Switchable sensing 7-day programmable thermostat	Yes	Yes	3450W @ 230V	£79.95
13741	088L0121	Danfoss ECTemp Plus electric floor heating room thermostat	Yes	Yes	3680 W @ 230 V	£84.00
12133	140F1140	DEVreg Smart programmable thermostat – Polar white (also available in black)	Yes	Yes	3680W @ 230V	£130.57
13260	1244-013810	Raychem Green Leaf touch screen programmable thermostat	Yes	Yes	3000W @ 230V	£79.91

All prices shown are exclusive of VAT



Best Price Guarantee



FREE Next Day Delivery



FREE Design Service



Smart Customer Service



Expert Technical Advice

# eFoil

ULTRA-THIN FOIL MAT FOR LAMINATE/WOOD FLOORS



Intertek



FULL EARTH PROTECTION



eFoil is an ultra-thin electric radiant floor heating system primarily for use under laminate, engineered wood and glued hardwood. Uniform heating is achieved by the specialised materials used, which also eliminates problems due to hotspots or localised heating.

As the eFoil is fully earth protected and covered in aluminium foil, the mat can be installed in wet areas, including bathrooms and kitchens.

## Features

- Ultra-thin heating cable
- Twin conductor heating cable
- Complete earth braiding
- Easy to install

## Specification

Thickness	5mm
Output	140W/m <sup>2</sup>
Operating voltage	230/240V
Cold tail connection lead	3m



When using eFoil, our XPS insulation boards must be laid first (see page 17).



Download a PDF datasheet

## Application

eFoil can be installed under laminate, engineered wood or glued hardwood. XPS insulation boards (see page 17) must be laid first, before laying the eFoil.



## Lifetime Warranty

eMat, eFoil, eFlex & eCable are guaranteed against manufacturer defects throughout the lifetime of the original floor covering laid over the underfloor installation.



## eFoil Mat Only

Select the eFoil to suit your room coverage. Then choose a thermostat, fixing kit and XPS underlay boards.

Q/F	Part Code	Dimensions	Coverage	Wattage	List Price
13154	eFoil140-1.0	0.5m × 2m	1.00m <sup>2</sup>	140w	£64.34
13155	eFoil140-1.5	0.5m × 3m	1.50m <sup>2</sup>	210w	£78.69
13156	eFoil140-2.0	0.5m × 4m	2.00m <sup>2</sup>	280w	£92.62
13157	eFoil140-2.5	0.5m × 5m	2.50m <sup>2</sup>	350w	£106.56
13158	eFoil140-3.0	0.5m × 6m	3.00m <sup>2</sup>	420w	£120.90
13159	eFoil140-3.5	0.5m × 7m	3.50m <sup>2</sup>	490w	£134.02
13160	eFoil140-4.0	0.5m × 8m	4.00m <sup>2</sup>	560w	£148.77
13161	eFoil140-5.0	0.5m × 10m	5.00m <sup>2</sup>	700w	£177.05
13162	eFoil140-6.0	0.5m × 12m	6.00m <sup>2</sup>	840w	£204.92
13163	eFoil140-7.0	0.5m × 14m	7.00m <sup>2</sup>	980w	£233.20
13164	eFoil140-8.0	0.5m × 16m	8.00m <sup>2</sup>	1120w	£262.50
13165	eFoil140-9.0	0.5m × 18m	9.00m <sup>2</sup>	1260w	£290.78
13166	eFoil140-10.0	0.5m × 20m	10.00m <sup>2</sup>	1400w	£319.06
13167	eFoil140-12.0	0.5m × 24m	12.00m <sup>2</sup>	1680w	£372.20

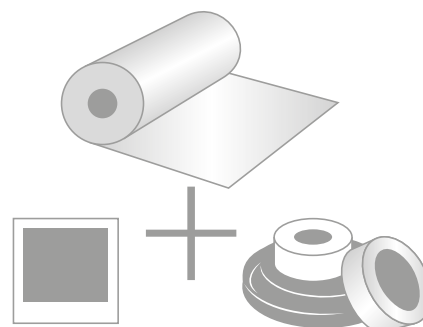

### eFoil Fixing Kit

- 1 × Aluminium adhesive tape (45m)
- 1 × Double Sided Tape (25m)
- 1 × Flexible conduit for floor sensing thermostat per metre

Q/F	List Price
18044	£19.95



When using eFoil, XPS insulation boards must be laid first

### XPS Panel

Q/F	Part Code	Dimensions	Coverage	List Price
13528	018793	1200mm × 600mm × 6mm	0.72m <sup>2</sup>	£4.64
13529	019289	1200mm × 600mm × 10mm	0.72m <sup>2</sup>	£6.08
13530	019385	1200mm × 600mm × 20mm	0.72m <sup>2</sup>	£11.96

## Thermostats SEE FULL LIST ON PAGE 21

Q/F	Part Code	Description	Room	Floor	Switching Capacity	List Price
16435	HTP100	Harmoni 100+ Wi-Fi touch screen 7-day programmable thermostat	Yes	Yes	3680W@230V	£165.38
16434	HT100	Harmoni 100 Touch screen 7-day programmable thermostat	Yes	Yes	3680W@230V	£114.00
8298	140G0052	Harmoni 25 Digital timer 7-day programmable thermostat	Yes	Yes	2990W @ 230V	£61.70
760	eStat760	eStat 760 Switchable manual non-programmable thermostat	Yes	Yes	3450W @ 230V	£49.95
763	eStat763	eStat 763 Switchable sensing 7-day programmable thermostat	Yes	Yes	3450W @ 230V	£79.95
13741	088L0121	Danfoss ECtemp Plus electric floor heating room thermostat	Yes	Yes	3680 W @ 230 V	£84.00
12133	140F1140	DEVlreg Smart programmable thermostat – Polar white (also available in black)	Yes	Yes	3680W @ 230V	£130.57
13260	1244-013810	Raychem Green Leaf touch screen programmable thermostat	Yes	Yes	3000W @ 230V	£79.91

All prices shown are exclusive of VAT



# eFlex

UNDER TILE  
LOOSE LAID CABLE



The eFlex loose laid cable system provides a flexible and easy under tile heating solution for any floor size or shape. Provides efficient warmth in areas such as small rooms or hallways or can be used to help dry wet floors in bathrooms or wet rooms.

Suitable for use beneath most floor types such as ceramic and porcelain tiles, limestone etc. Its thin heating element keeps floor depth to a minimum.

## Features

- Easy to install
- Twin conductor heating cable
- Suitable for most floor surfaces
- Can install within the thickness of tile adhesive

## Specification

Conductor	Twin
Voltage	230V
Output	10W/1m
Thickness	4mm
Min. bending radius	30mm



Download a PDF  
datasheet



## Application

The eFlex is a loose laid cable which can be installed beneath most ceramic, porcelain/slate and natural stone tiles. When using laminate, engineered timber or vinyl floors a self-levelling compound should be used.

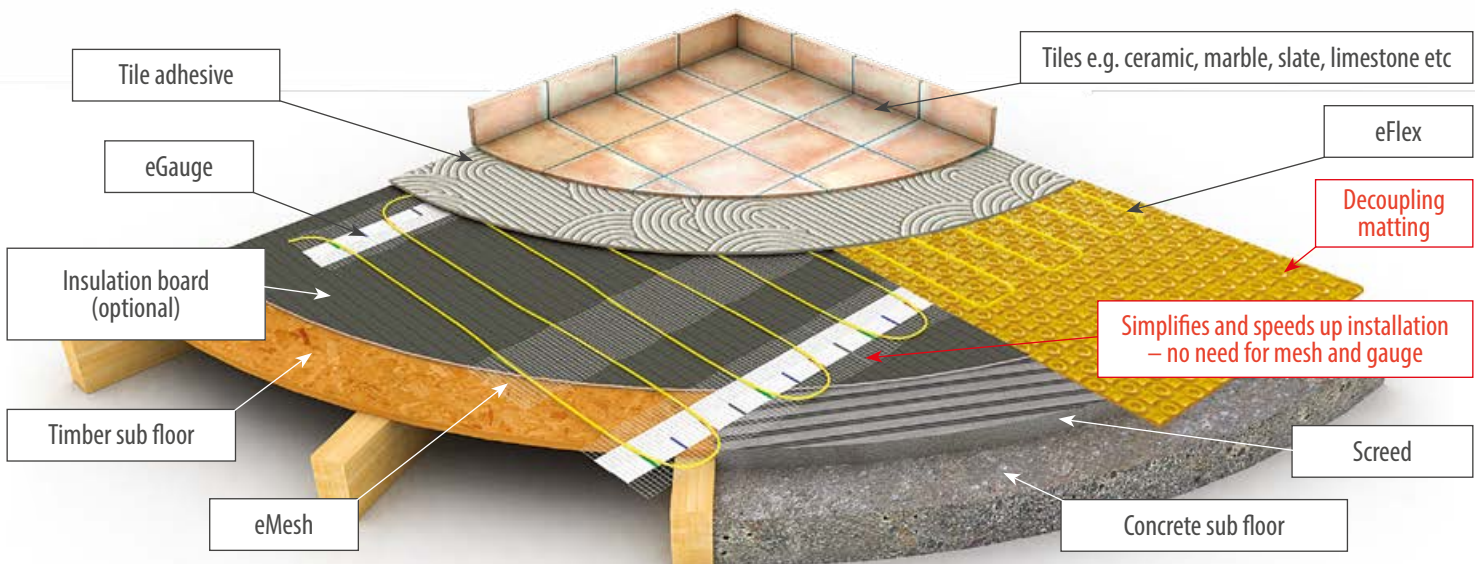

## eFlex Cable Only

Select the eFlex cable to suit your room coverage. Then choose a thermostat and either decoupling mats or eFlex fixings.

Q/F	Part Code	Length	Wattage	List Price
13517	EF50	5m	50w	£48.83
13518	EF100	10m	100w	£58.83
16216	EF200	20m	200w	£68.83
13519	EF300	30m	300w	£78.83
13520	EF400	40m	400w	£92.83
13521	EF600	60m	600w	£145.83
13522	EF800	80m	800w	£172.71
13523	EF1000	100m	1000w	£266.67
13524	EF1200	120m	1200w	£286.08
13525	EF1400	140m	1400w	£308.18
13526	EF1600	160m	1600w	£349.97

## eFlex Fixing Kit

Q/F	Part Code	List Price
1310	eFixKit	£19.50

## Dural Durabase

Q/F	Part Code	Dimensions	Coverage	List Price
18118	CI-FH/1m	1m x 1m	1m <sup>2</sup>	£9.16
18090	CI-FH/5	5m x 1m	5m <sup>2</sup>	£47.40
18093	CI-FH/15	15m x 1m	15m <sup>2</sup>	£128.60

Choose either the **decoupling mat** or **eFlex fixings** to space and fix the eFlex cable.

## Durabase Decoupling Mat

Dural Durabase CI-FH is a decoupling matting system that doubles as a carrier for the eFlex. It allows the heating cables to be positioned where the heat is required in the room.

The Durabase can speed up the installation process and protect the cable from potential trowel damage while embedding in adhesive or self-smoothing screed. *See page 18 for more details.*



## eFlex Fixings

- **eFix:** Heat-resistant double-sided tape
- **eGauge:** Measuring tape with 25mm spaced coloured stripes that helps speed up the installation process
- **eMesh:** Fibre tape that allows tile adhesive to pass through it, eliminating problems caused by air gaps under the tiles.

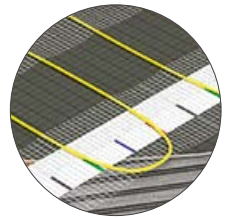

Lay the eFlex onto the eFix and position over the eGauge at the appropriate coloured stripe. Then lay the eMesh on top.

## Thermostats SEE FULL LIST ON PAGE 21

Q/F	Part Code	Description	Room	Floor	Switching Capacity	List Price
16435	HTP100	Harmoni 100+ Wi-Fi touch screen 7-day programmable thermostat	Yes	Yes	3680W@230V	£165.38
16434	HT100	Harmoni 100 Touch screen 7-day programmable thermostat	Yes	Yes	3680W@230V	£114.00
8298	140G0052	Harmoni 25 Digital timer 7-day programmable thermostat	Yes	Yes	2990W@230V	£61.70
760	eStat760	eStat 760 Switchable manual non-programmable thermostat	Yes	Yes	3450W@230V	£49.95
763	eStat763	eStat 763 Switchable sensing 7-day programmable thermostat	Yes	Yes	3450W@230V	£79.95
13741	088L0121	Danfoss ECTemp Plus electric floor heating room thermostat	Yes	Yes	3680 W@230 V	£84.00
12133	140F1140	DEVireg Smart programmable thermostat – Polar white (also available in black)	Yes	Yes	3680W@230V	£130.57
13260	1244-013810	Raychem Green Leaf touch screen programmable thermostat	Yes	Yes	3000W@230V	£79.91

All prices shown are exclusive of VAT



# eCable

IN-SCREED TOTAL HEATING SOLUTION



The eCable underfloor heating product offers a flexible solution for most new build applications where a total heating solution is required.

The flexibility of the cable installation allows variable power outputs to be installed with a maximum of 230 W/m<sup>2</sup>.

This system will provide a total heating solution in most installation scenarios including conservatories and sun rooms.

## Features

- Easy to install
- Twin conductor heating cable
- Variable power outputs
- Suitable for most floor surfaces

## Specification

Conductor	Twin
Voltage	230V
Nominal power	20W/m
Diameter	7mm



Download a PDF datasheet



## Application

The eCable underfloor heating product offers a flexible solution for most new build applications where a total heating solution is required.

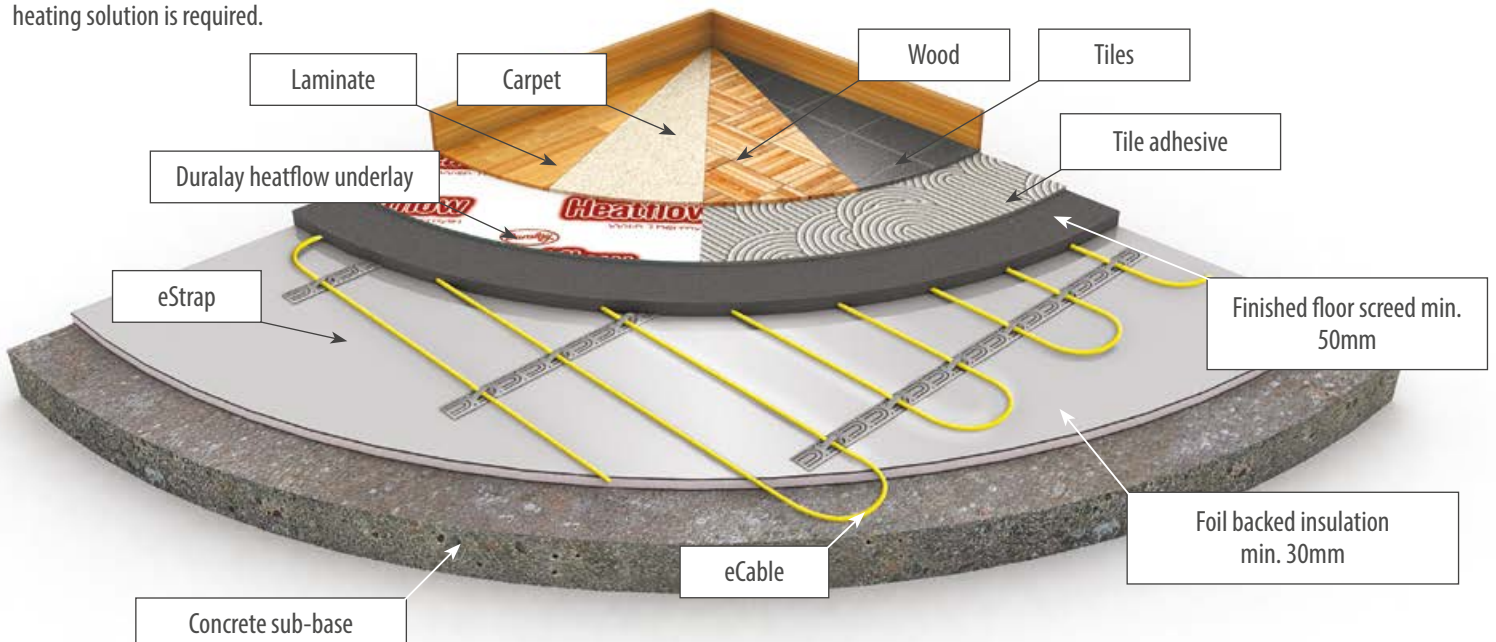

## eCable Only

Select the eCable to suit your room coverage. Then choose a thermostat and a fixing kit (eStrap, flexible conduit and utility tape).

Q/F	Part Code	Wattage	Coverage*	List Price
13507	EC425	425W	2.0m	£75.58
13508	EC650	650W	3.0m	£103.25
13509	EC830	830W	4.0m	£125.39
13510	EC970	970W	5.0m	£135.76
13511	EC1270	1270W	6.0m	£165.38
13512	EC1410	1410W	7.0m	£174.46
13513	EC1620	1620W	8.0m	£196.65
13514	EC1890	1890W	9.0m	£208.75
13515	EC1980	1980W	10.0m	£220.85
13516	EC2530	2530W	11.0–12.0m	£238.69
13980	EC2680	2680W	13.0–14.0m	£466.16
13981	EC3030	3030W	15.0–16.0m	£497.43
13982	EC3960	3960W	17.0–19.0m	£568.02
13983	EC4510	4510W	20.0–23.0m	£627.25
13984	EC5850	5850W	24.0–27.0m	£806.06
13985	EC6490	6490W	28.0–30.0m	£848.10
13986	EC7590	7590W	31.0–34.0m	£883.78
13987	EC7920	7920W	35.0–38.0m	£1051.11
13988	EC9020	9020W	39.0–42.0m	£1086.71

\*Coverage based on 200W/m<sup>2</sup> ideally suited for conservatories and sunrooms.



### Free design service

We offer a free electric underfloor heating design service and can guide you through the process.

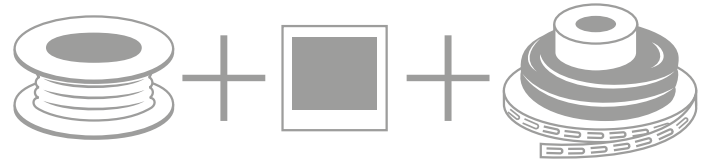

### eCable Fixing Kit

- 1 × Single sided utility duct tape (50m)
- 1 × Metal fixing strap
- 1 × Flexible conduit for floor sensing thermostat per metre

Q/F	Part Code	List Price
18047	CFKIT-Type1	£46.37

## Thermostats SEE FULL LIST ON PAGE 21

## eStrap

The eStrap ensures the eCable is evenly spaced and secured to the insulation or concrete based floor.



Q/F	Part Code	Description	Room	Floor	Switching Capacity	List Price
16435	HTP100	Harmoni 100+ Wi-Fi touch screen 7-day programmable thermostat	Yes	Yes	3680W@230V	£165.38
16434	HT100	Harmoni 100 Touch screen 7-day programmable thermostat	Yes	Yes	3680W@230V	£114.00
8298	140G0052	Harmoni 25 Digital timer 7-day programmable thermostat	Yes	Yes	2990W @ 230V	£61.70
760	eStat760	eStat 760 Switchable manual non-programmable thermostat	Yes	Yes	3450W @ 230V	£49.95
763	eStat763	eStat 763 Switchable sensing 7-day programmable thermostat	Yes	Yes	3450W @ 230V	£79.95
13741	088L0121	Danfoss ECtemp Plus electric floor heating room thermostat	Yes	Yes	3680 W @ 230 V	£84.00
12133	140F1140	DEVreg Smart programmable thermostat – Polar white (also available in black)	Yes	Yes	3680W @ 230V	£130.57
13260	1244-013810	Raychem Green Leaf touch screen programmable thermostat	Yes	Yes	3000W @ 230V	£79.91

All prices shown are exclusive of VAT



# ePanel Boards

INSULATED TILE BACKING BOARDS

For use with

eMat Pro

eFlex



ePanel Thermal is a lightweight insulated tile backing board developed specifically for use with tile floors. It consists of a polyfoam core with glass fibre reinforced polymer-modified cement faces, making it the ideal substrate for floor tiling and under tile heating systems.

## Application

ePanel Thermal is suitable for both domestic and commercial use. It is designed to be installed beneath both the eMat Pro and eFlex, to provide a high level of insulation and a stable base for tiling (on timber based floors). The ePanel board can be secured using ePanel fixings (when laying on timber floors), whilst using the eMesh to strengthen the joints.

## Features

- Dimensionally stable, does not rot or warp
- Excellent resistance to moisture
- High level of thermal insulation
- Extremely light and easy to cut

## ePanel

Q/F	Part Code	Dimensions	Coverage	List Price
1133	ePanel 6mm	1200mm × 600mm × 6mm	0.72m <sup>2</sup>	£13.75
1086	ePanel 10mm	1200mm × 600mm × 10mm	0.72m <sup>2</sup>	£14.50
1268	ePanel 20mm	1200mm × 600mm × 20mm	0.72m <sup>2</sup>	£16.38

## Accessories

Q/F	Part Code	Qty	Length	List Price
1135	eFixings	50 per bag	–	£9.61
1311	eMesh46	1	46m	£14.75



Secure the ePanel to a timber sub-base using ePanel fixings.  
Use eMesh to strengthen the joints of the ePanel.



### ePanel Fixings

For securing ePanel boards (includes screws)



### eMesh

Self-adhesive alkaline resistant mesh for fixing cables and ePanels



## For use with

eFoil

# XPS Insulation Boards

EXTRUDED POLYSTYRENE BOARDS

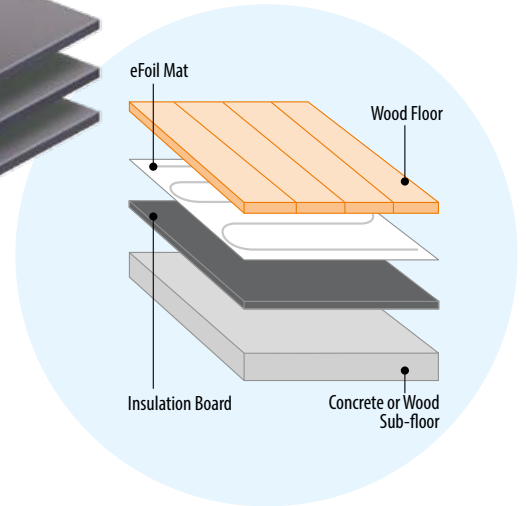
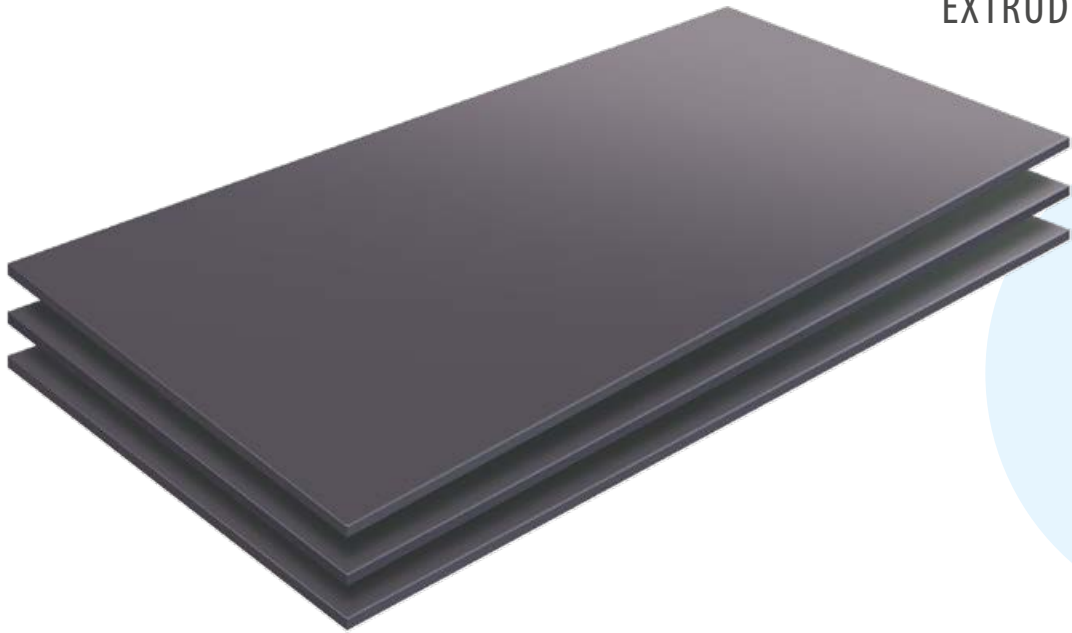

The XPS insulation board has been specifically designed to provide a high level of insulation with poorly insulated concrete/screeded bases. The board is constructed from extruded polystyrene, a durable, lightweight material with high compressive strength, giving it the ability to resist compressive creep and fatigue.

## Application

The XPS insulation board is suitable for both domestic and commercial use. The boards should be installed beneath the eFoil in a brick pattern and secured along the joints using adhesive tape to prevent movement of the underlay during installation.

## Features

- Dimensionally stable, does not rot or warp
- Excellent resistance to moisture
- High level of thermal insulation
- Extremely light and easy to cut

## XPS Panel

Q/F	Part Code	Dimensions	Coverage	List Price
13528	018793	1200mm × 600mm × 6mm	0.72m <sup>2</sup>	£4.64
13529	019289	1200mm × 600mm × 10mm	0.72m <sup>2</sup>	£6.08
13530	019385	1200mm × 600mm × 20mm	0.72m <sup>2</sup>	£11.96

## Accessories

Q/F	Part Code	Description	Length	List Price
1247	ESS50	Single sided tape	50m	£4.26
1246	EDS25	Double sided tape	25m	£6.37
1245	EDS50	Double sided tape	50m	£8.69

### Adhesive Tape

Multi-purpose fixing tape



### eFix

60°C Heat resistant double-sided tape



Secure the XPS insulation boards together using our adhesive tape.

# Decoupling Matting

UNDERFLOOR HEATING CARRIER MAT

For use with

eFlex



Download a PDF  
datasheet

Dural Durabase CI-FH is a decoupling matting that doubles as a carrier for electric underfloor heating cables (see eFlex on page 13). It speeds up the installation as there is no need to lay uncoupling matting then underfloor heating mats separately. The matting can also protect the cable from potential trowel damage while embedding in adhesive or self-smoothing screed. The matting is available in rolls of 1m, 5m and 15m lengths.

## Application

Dural Durabase is ideal for use with our eFlex cable. The raised studs act as a measuring tool, ensuring the cables are the correct distance apart and allows cables to be positioned where the heat is needed in the room. The matting also absorbs the stresses and pressure caused by underfloor heating, helping to prevent cracked tiles.

## Features

- Heating cables can be positioned where the heat is required
- Protects cables from trowel work
- Can be cut to size
- Helps speed up installation

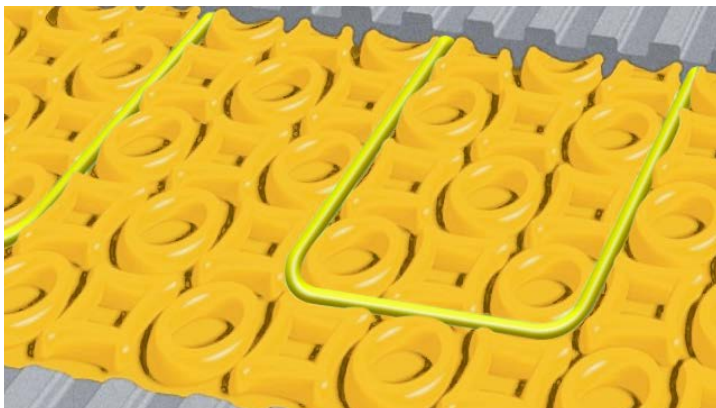

## Dural Durabase

Q/F	Part Code	Dimensions	Coverage	List Price
18118	CI-FH/1m	1m × 1m	1m <sup>2</sup>	£9.16
18090	CI-FH/5	5m × 1m	5m <sup>2</sup>	£47.40
18093	CI-FH/15	15m × 1m	15m <sup>2</sup>	£128.60

## Dural Sealing & Joining Tape

Q/F	Part Code	Dimensions	List Price
18094	WPFB-120/10	120mm (W) × 10m (L)	£23.04

Sealing & joining tape is supplied as a handy roll for use at the joints on Dural DuraBase matting.

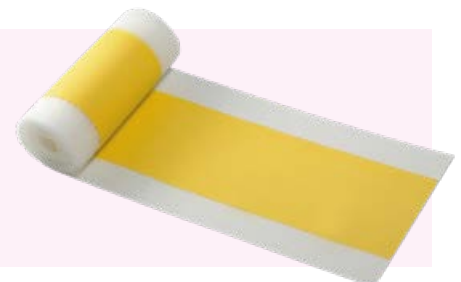

# Accessories

## UNDERFLOOR HEATING ELECTRICAL ACCESSORIES & SPARES



**eFix**  
60° Heat resistant double-sided tape

Q/F	Part Code	Length	List Price
1246	EDS25	25m	£6.37
1245	EDS50	50m	£13.38



**Adhesive Tape**  
Multi-purpose fixing tape

Q/F	Part Code	Length	List Price
1247	ESS50	50m	£4.26



**ePanel Fixings**  
For securing ePanel boards (includes screws)

Q/F	Part Code	Qty	List Price
1135	eFixings	50 per bag	£9.61



**eGauge**  
Spacing tape designed for eCable and eFlex systems

Q/F	Part Code	Roll Size	List Price
1308	EG25	25m	£1.85
1312	EG50	50m	£2.75



**eMesh**  
Self-adhesive alkaline resistant mesh for fixing cables & ePanels

Q/F	Part Code	Length	List Price
1311	eMesh46	46m	£14.75



**Superspray**  
General purpose adhesive spray

Q/F	Part Code	Coverage	List Price
434	S707	3-4m <sup>2</sup>	£3.99



**Floor Sensor**  
For DEVItouch and eStat thermostats

Q/F	Part Code	Thermostat	List Price
1019	floorsensor	eStat	£16.50
273	140F1091	DEVItouch	£18.15



**Snubber**  
To be used with a contactor

Q/F	Part Code	List Price
1022	snubber	£5.50



**Repair Kit**  
For underfloor heating mats

Q/F	Part Code	List Price
236	repairkit	£17.94



**eFlex Fixing Kit**  
Includes 50m eFix, 50m eGauge and 46m eMesh

Q/F	Part Code	List Price
1310	eFixKit	£19.50



**eMat Fixing Kit**  
Includes adhesive spray, duct tape & flexible conduit

Q/F	Part Code	List Price
17667	MAT-FIX-KIT	£8.97



**eCable Fixing Kit**  
Includes a metal fixing strap, duct tape & flexible conduit

Q/F	Part Code	List Price
18047	CFKIT-Type1	£46.37



**eFoil Fixing Kit**  
Includes 45m aluminium adhesive tape, 25m double sided tape & flexible conduit

Q/F	Part Code	List Price
18044	ETH-1798	£19.95

### COMPLETE TRACE HEATING SOLUTIONS FOR ALL APPLICATIONS



Call us on: 01473 276672  
Buy online: [www.traceheatinguk.co.uk](http://www.traceheatinguk.co.uk)  
Email us: [sales@traceheatinguk.co.uk](mailto:sales@traceheatinguk.co.uk)



**Trace Heating UK**  
Domestic | Commercial | Industrial

# Adhesives, Levellers & Primers

A RANGE OF PRODUCTS FOR FLOOR LEVELLING, TILE APPLICATION & FINISHING



## Ultra-Floor Self-levelling Compound

Q/F	Part Code	Description	Set Time	Weight	List Price
9125	LEVELITWO	Ultra Level IT 2 Self-levelling Compound	2.5hrs	29kg	£19.00
18087	ProLevel Fibre	ProLevel Fibre Reinforced Flexible Deep Fill Self-leveller 3–75mm	3hrs	20kg	£18.00

## Tile Adhesives

Q/F	Part Code	Colour	Depth	Set Time	Weight	List Price
9101	RSFGRE	Grey	3–16mm	2.5hrs	20kg	£16.30
9102	RSFWHI	White	3–16mm	2.5hrs	20kg	£22.01
9107	PSFGRE	Grey	3–20mm	2.5hrs	20kg	£23.13
9108	PSFWHI	White	3–20mm	2.5hrs	20kg	£24.65
9106	UPSGRE	Grey	3–20mm	16hrs	20kg	£22.38
9105	UPSWHI	White	3–20mm	16hrs	20kg	£23.88



## Primers

Q/F	Part Code	Pack Size	Drying Time	List Price
10304	BALPRIMEAPD	2.5L	15–30 minutes	£29.73
18088	ProPrimer 1 Litre	1L	45 minutes	£6.09
18089	ProPrimer 5 Litre	5L	45 minutes	£21.03

## Free design service

A bespoke design is a prerequisite to maximise the performance and efficiency of an electric underfloor heating system.

Our technical team are experienced in working out the intricacies of underfloor heating systems. Taking into account the size, type of space and floor finish, they can advise on the most suitable solution before designing the system – and best of all, it's a free service.



harmoni

Danfoss

DEVI®

prowarm™

heatmiser®

Raychem®



# Thermostats

A RANGE OF WI-FI, DIGITAL & MANUAL THERMOSTATS

We supply top brand thermostats ranging from cost-effective, basic thermostats to the latest energy saving digital touchscreen and smartphone controlled Wi-Fi thermostats that incorporate cutting-edge technology – ensuring total control from the initial setup.

## All Thermostats

Q/F	Part Code	Description	Room	Floor	Switching Capacity	List Price
<b>Wi-Fi</b>						
16435	HTP100	Harmoni 100+ Wi-Fi touch screen 7-day programmable thermostat	Yes	Yes	3680W@230V	£137.82
12133	140F1140	DEVlreg Smart programmable thermostat – Polar white	Yes	Yes	3680W@230V	£230.40
12132	140F1143	DEVlreg Smart programmable thermostat – Black	Yes	Yes	3680W@230V	£230.40
16124	PROTOUCH-E-WHITE	ProWarm ProTouch-E WiFi – White	Yes	Yes	3000W@230V	£179.99
16125	PROTOUCH-E-BLACK	ProWarm ProTouch-E WiFi – Black	Yes	Yes	3000W@230V	£179.99
14711	neoHub	Heatmiser neoHub Neo System Gateway G2 – Pair with Heatmiser neoStat-e electric thermostats (QF: 14718, 14719, 14720)				£125.00
<b>Digital</b>						
16434	HT100	Harmoni 100 Touch screen 7-day programmable thermostat	Yes	Yes	3680W@230V	£95.00
8298	140G0052	Harmoni 25 Digital timer 7-day programmable thermostat	Yes	Yes	2990W @ 230V	£61.70
764	140F1064	DEVlreg Touch programmable thermostat – Pure white	Yes	Yes	3680W@230V	£121.84
8096	140F1069	DEVlreg Touch programmable thermostat – Pure black	Yes	Yes	3680W@230V	£121.84
16955	PROTOUCHv2	ProWarm ProTouch v2 – White	Yes	Yes	3000W@230V	£168.00
16956	PROTOUCHv2	ProWarm ProTouch v2 – Black	Yes	Yes	3000W@230V	£168.00
13741	088L0121	Danfoss ECTemp Plus electric floor heating room thermostat	Yes	Yes	3680W@230V	£70.00
13260	1244-013810	Raychem Green Leaf touch screen programmable thermostat	Yes	Yes	3000W@230V	£120.50
763	eStat763	eStat 763 Switchable sensing 7-day programmable thermostat	Yes	Yes	3450W@230V	£79.95
17943	SLIMLINE-E	Heatmiser Slimline-e thermostat v3	Yes	Yes	3680W@230V	£50.42
14713	Touch-E v2	Heatmiser Touch-e thermostat white v2	Yes	Yes	3680W@230V	£39.37
14718	NEOSTAT-E-PLATINUM	Heatmiser neoStat-e electric thermostat (Platinum Silver) v2*	Yes	Yes	3680W@230V	£64.29
14719	NEOSTAT-E-BLACK	Heatmiser neoStat-e Electric thermostat (Black) v2*	Yes	Yes	3680W@230V	£64.29
14720	NEOSTAT-E-WHITE v2	Heatmiser neoStat-e electric thermostat (White) v2*	Yes	Yes	3680W@230V	£64.29
<b>Manual</b>						
206	140F1010	DEVlreg 130 floor sensing manual thermostat	No	Yes	3680W@230V	£72.74
302	140F1011	DEVlreg 132 floor & air sensing manual thermostat	Yes	Yes	3680W@230V	£91.44
607	140F1030	DEVlreg 530 floor sensing manual thermostat	No	Yes	3450W@230V	£88.68
714	140F1037	DEVlreg 532 floor & air sensing manual thermostat	Yes	Yes	3450W@230V	£95.04
760	eStat760	eStat 760 switchable manual non-programmable thermostat	Yes	Yes	3450W@230V	£49.95

# Harmoni Thermostats

harmoni

STYLISH CUTTING EDGE PROGRAMMABLE THERMOSTATS



Harmoni 100+ (Wi-Fi enabled) & Harmoni 100

QF: 16435 (100+)/16434 (100)

The Harmoni 100+ & Harmoni 100 are intelligent underfloor heating controls with a stylish touch screen display.

When used with the Harmoni App, the Harmoni 100+ can be controlled from a smart device wherever you are, whenever you want. And as the 100+ uses a Wi-Fi connection, it doesn't require a wired installation.

## Features

- Complete Wi-Fi control (100+ only)
- Manual / automatic / anti-frost modes
- Air & floor sensing
- 3 pre-installed programs

## Specification

- Supply voltage 230V
- Max. current 16A / 3680W
- IP rating IP21
- Unit size 77(W)×77(H)×15 mm(D)



Harmoni 25

QF: 8298

The Harmoni 25, 7-day programmable thermostat is an advanced digital timer thermostat used for controlling electrical underfloor heating elements.

Designed for fixed installation only, the Harmoni 25 controls your floor heating system by either the floor temperature, the room temperature or both together.

## Features

- Easy to set up
- Backlit display
- Air & floor sensing
- 2-year warranty

## Specification

- Supply voltage 230V
- Max. current 16A / 2990W
- Accuracy ±1°C
- Unit size 86(W)×86(H)×13mm(D)

## Harmoni Thermostats

Q/F	Part Code	Description	Room	Floor	Switching Capacity	List Price
16435	HTP100	Harmoni 100+ Wi-Fi touch screen 7-day programmable thermostat	Yes	Yes	3680W @ 230V	£165.38
16434	HT100	Harmoni 100 Touch screen 7-day programmable thermostat	Yes	Yes	3680W @ 230V	£114.00
8298	140G0052	Harmoni 25 Digital timer 7-day programmable thermostat	Yes	Yes	2990W @ 230V	£61.70

## Accessories

Q/F	Part Code	Description	List Price
273	floorsensor	Spare floor sensor for Harmoni thermostats	£18.15
1022	snubber	To be used with a contactor	£5.50

# eStat Thermostats

MANUAL & FULLY PROGRAMMABLE  
COMPACT THERMOSTATS



eStat 763



eStat 760



## QF: 763

The eStat 763 provides total control and flexibility. It can switch a maximum of 15 amps, enabling multiple mats to be switched using one thermostat control. For areas requiring a single thermostat to control a load greater than 15 amps, a suitably sized contactor\* should be installed, controlled by the thermostat.

\*Please note: When a contactor is used, a snubber (surge protector) must be fitted on the switch terminals (A1 & A2).

## Features

- Programmable thermostat
- 3 function modes
- Comfort & economy pre-set temperatures
- 3-year warranty

## Specification

- Supply voltage 230V
- Max. current 16A / 2990W
- Accuracy  $\pm 1^{\circ}\text{C}$
- Unit size 86(W) $\times$ 86mm(H) $\times$ 13mm(D)

## eStat

Q/F	Part Code	Description	Room	Floor	Switching Capacity	List Price
760	eStat760	Switchable manual non-programmable eStat	Yes	Yes	3450W @ 230V	£49.95
763	eStat763	Switchable electronic 7 day programmable eStat	Yes	Yes	3450W @ 230V	£79.95

## QF: 760

The eStat 760 is a simple-to-use manual thermostat, controlled using an on/off switch and a single large dial. It allows the user to control the heating system in three ways: floor only, air only and a combination of air & floor. As with the eStat 763, the eStat 760 can switch multiple mats using one thermostat control up to a maximum of 15 amps.

## Features

- Manual thermostat
- Floor sensing
- Simple dial control
- 3-year warranty

## Specification

- Supply voltage 230V
- Max. current 16A / 3450W
- Accuracy  $\pm 0.2^{\circ}\text{C}$  (0.36°F)
- Unit size 75(W) $\times$ 75(H) $\times$ 14mm(D)

## Accessories

Q/F	Part Code	Description	List Price
1019	floorsensor	Spare floor sensor for eStat thermostat controls	£16.50
1022	snubber	To be used with a contactor	£5.50

# Heatmiser Thermostats



## Heatmiser Slimline-e

QF: 17943

The Heatmiser Slimline-e programmable thermostat is a underfloor heating thermostat and programmer in one, providing up to 4 different temperatures at different times of the day.

Features an automatic white back-lit display that turns off after 30 seconds.

### Features

- Automatic white back-lit display
- Temperature hold facility
- 4 comfort levels per day
- Keylock facility

### Specification

- Supply voltage 230V
- Max. current 16A / 3680W
- Accuracy +/-1°C
- Unit size 99(W)×86mm(H)×15mm(D)



## Heatmiser Touch-e

QF: 14713

The Heatmiser Touch-e is a modern thermostat featuring a large touchscreen display that makes programming it simple.

The Touch can be paired with a wireless air sensor or a window/door switch, a great energy-saving feature.

### Features

- Heating or timer mode
- Self-learning optimum start
- Temperature hold & holiday facility
- 4 or 6 comfort levels per day (selectable)

### Specification

- Supply voltage 230V
- Max. current 16A / 3680W
- Unit size 107(W)×86(H)×15mm(D)
- Sensing NTC 15K accuracy: ±1%

Available in Black, Platinum & White



## Heatmiser neoStat-e

QF: 14718 (platinum)/14719 (black)/14720 (white)

A digital thermostat offering a smarter way to control electric floor heating. Pair to a neoHub (sold separately) to create a home heating network system that can be fully controlled from anywhere.

The neoStat-e can work either as a thermostat or a timer so it's able to control towel rails and lighting too. It comes with a 3 metre remote floor sensor.

### Features

- White back light with proximity sensor
- Flexible programming & holiday facility
- Flush mounting
- Wi-Fi compatible when paired with the Neohub

### Specification

- Supply voltage 230V
- Max. current 16A / 3680W
- IP rating IP20
- Unit size 85(W)×85mm(H)×15mm(D)

## Convert the Heatmiser neoStat into a Wi-Fi enabled thermostat with the neoHub

The Heatmiser neoHub is the gateway to the Neo System, providing remote control for all neoStat thermostats from iOS, Android and Windows 10 devices.

The neoHub connects to a home broadband router and wirelessly to all the neoStats in the house. Simply plug it into the router, create a free account via the Neo App and then control heating, hot water and appliances from anywhere.



QF: 14711

SEE PAGE 21 FOR PRICES



# Pre-made Trace Heating Kits

THE PERFECT SOLUTION TO  
PREVENT PIPES FROM FREEZING



EASY TO  
INSTALL



Trace heating kits are the perfect solution to prevent pipes from freezing. Simple to fit, our frost protection kits use a self-regulating trace heating cable which limits its output per metre by using a variable resistive compound within the cable to prevent overheating and ensure efficient operation. The built-in thermostat ensures that the frost protection system only operates when required to stop pipes freezing throughout winter and remains dormant during the warmer months.

## Features

- Pre-terminated trace heating cable
- Built-in thermostat
- Warning labels, cable ties & 13 amp 3-pin plug included

## Trace Heating Kits

Q/F	Part Code	Description	List Price
13478	FP-230-2	2m Pre-made (12W/m) Frost Protection Kits	£40.00
13479	FP-230-4	4m Pre-made (12W/m) Frost Protection Kits	£52.69
13480	FP-230-5	5m Pre-made (12W/m) Frost Protection Kits	£57.69
13481	FP-230-6	6m Pre-made (12W/m) Frost Protection Kits	£62.69
13482	FP-230-8	8m Pre-made (12W/m) Frost Protection Kits	£72.69
13483	FP-230-10	10m Pre-made (12W/m) Frost Protection Kits	£82.69
13484	FP-230-15	15m Pre-made (12W/m) Frost Protection Kits	£107.69
13485	FP-230-25	25m Pre-made (12W/m) Frost Protection Kits	£157.69
13486	FP-230-30	30m Pre-made (12W/m) Frost Protection Kits	£182.69

## Specification

Supply voltage	230V
Cold lead length	2m
Max. exposure temperature (de-energised)	85°C
Max. exposure temperature (energised)	65°C
Min. bend radius	25mm
Min. fuse (type C)	10A
IP classification	IP 67

## Accessories

Q/F	Part Code	Description	List Price
1798	ETH-1798	Aluminium tape	£20.89
4675	9501	Heat resistant glass fibre fixing tape	£4.37

# eDemist

KEEPS MIRRORS FREE OF CONDENSATION

Contact us for your discounted prices

*demista*<sup>TM</sup>

**10 YEAR WARRANTY**



An ultra-thin self-adhesive heating pad that fits inconspicuously behind virtually any mirror, resulting in a completely mist-free surface within a few minutes of switching on. Simple to fit with minimal running costs, these pads are technologically advanced and capable of maintaining a high degree of temperature stability with complete resistance to moisture, vibration, shock, dust and ageing.

## Features

- Keeps mirrors crystal clear
- Simple to fit
- Economical to run & maintenance free
- Approved to international standards
- Double insulated
- Manufactured in the UK, comes with a 10-year warranty

## Specification

Pad thickness	Less than 1mm
Terminal block	35mm Ø, 7mm depth
1 metre twin core	0.5mm oval cable
Power rating	200W/m <sup>2</sup>

Contact us for more information

**01473 276677**

[sales@elementsunderfloorheating.co.uk](mailto:sales@elementsunderfloorheating.co.uk)

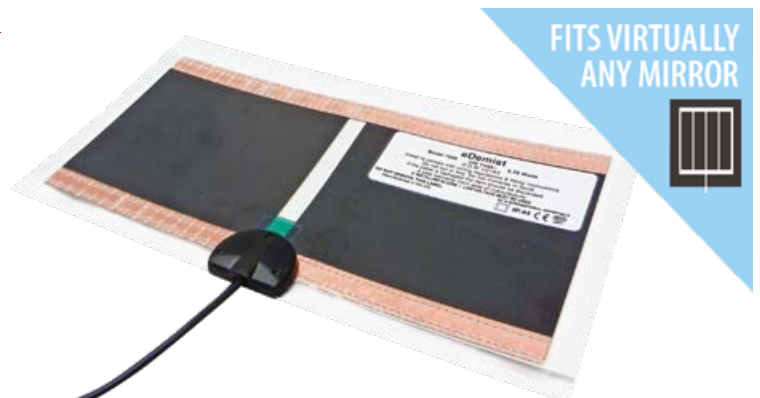

## Demister Pads 230V

Q/F	Part Code	Dimensions (W×H)	Area	List Price
14739	7015L025	150 × 250 mm	0.04 m <sup>2</sup>	£41.54
14855	7030L033	300 × 330 mm	0.10 m <sup>2</sup>	£45.18
14859	7030L049	300 × 490 mm	0.15 m <sup>2</sup>	£50.61
14863	7030L065	300 × 650 mm	0.19 m <sup>2</sup>	£56.11
14869	7030L089	300 × 890 mm	0.27 m <sup>2</sup>	£63.32
14871	7030L097	300 × 970 mm	0.29 m <sup>2</sup>	£66.03
14879	7030L129	300 × 1290 mm	0.39 m <sup>2</sup>	£76.03
14881	7030L137	300 × 1370 mm	0.41 m <sup>2</sup>	£78.82
14914	7040L041	400 × 410 mm	0.16 m <sup>2</sup>	£50.22
14919	7040L061	400 × 610 mm	0.24 m <sup>2</sup>	£57.58
14920	7040L065	400 × 650 mm	0.26 m <sup>2</sup>	£59.68
14922	7040L073	400 × 730 mm	0.29 m <sup>2</sup>	£61.77
14924	7040L081	400 × 810 mm	0.32 m <sup>2</sup>	£64.87
14926	7040L089	400 × 890 mm	0.36 m <sup>2</sup>	£68.12
14929	7040L101	400 × 1010 mm	0.40 m <sup>2</sup>	£72.39
14967	7050L025	500 × 250 mm	0.12 m <sup>2</sup>	£46.58
14973	7050L049	500 × 490 mm	0.24 m <sup>2</sup>	£56.42
14985	7050L097	500 × 970 mm	0.48 m <sup>2</sup>	£77.5
14998	7050L149	500 × 1490 mm	0.74 m <sup>2</sup>	£99.82
15033	7060L061	600 × 610 mm	0.37 m <sup>2</sup>	£66.26
15048	7060L121	600 × 1210 mm	0.73 m <sup>2</sup>	£97.19
15087	7070L049	700 × 490 mm	0.34 m <sup>2</sup>	£62.23
15099	7070L097	700 × 970 mm	0.68 m <sup>2</sup>	£88.97
15100	7070L101	700 × 1010 mm	0.70 m <sup>2</sup>	£90.29
15104	7070L117	700 × 1170 mm	0.82 m <sup>2</sup>	£99.90
13006	7070L141	700 × 1410 mm	0.98 m <sup>2</sup>	£112.30
15124	7070L197	700 × 1970 mm	1.38 m <sup>2</sup>	£144.00
15010	7050L197	500 × 1970 mm	0.98 m <sup>2</sup>	£120.98
15081	7070L025	700 × 250 mm	0.17 m <sup>2</sup>	£49.83
15112	7070L149	700 × 1490 mm	1.04 m <sup>2</sup>	£117.18
14745	7015L049	150 × 490 mm	0.07 m <sup>2</sup>	£47.43
14757	7015L097	150 × 970 mm	0.15 m <sup>2</sup>	£59.52
14796	7020L025	200 × 250 mm	0.05 m <sup>2</sup>	£42.39



- Demister pads are available in a huge range of sizes to fit virtually any mirror
- We also supply 120V, 24V & 12V low-voltage models

**Call us on 01473 276677 for advice or more details about all the options available**



The 120V, 24V and 12V demister pads require a transformer to operate in the UK. If you are unsure of your product choice please contact us for more information.



## 12V Transformers

Q/F	Part Code	Model	List Price
13019	300057	5-40VA Mirror Demister Transformer	£29.95
13020	300056	35-40VA Mirror Demister Transformer	£27.45
13021	300050	35-105VA Mirror Demister Transformer	£32.45
13022	300051	50-150VA Mirror Demister Transformer	£51.20
13023	300052	50-210VA Mirror Demister Transformer	£61.20
13024	300053	50-255VA Mirror Demister Transformer	£76.20

## Accessories

Q/F	Part Code	Description	Length	List Price
13018	SPDL030	Demista Heated Mirror Demister Pad Door Loop	450mm	£18.75



# Heating Design Service

FREE BESPOKE DESIGN FOR YOUR ENTIRE HEATING SYSTEM

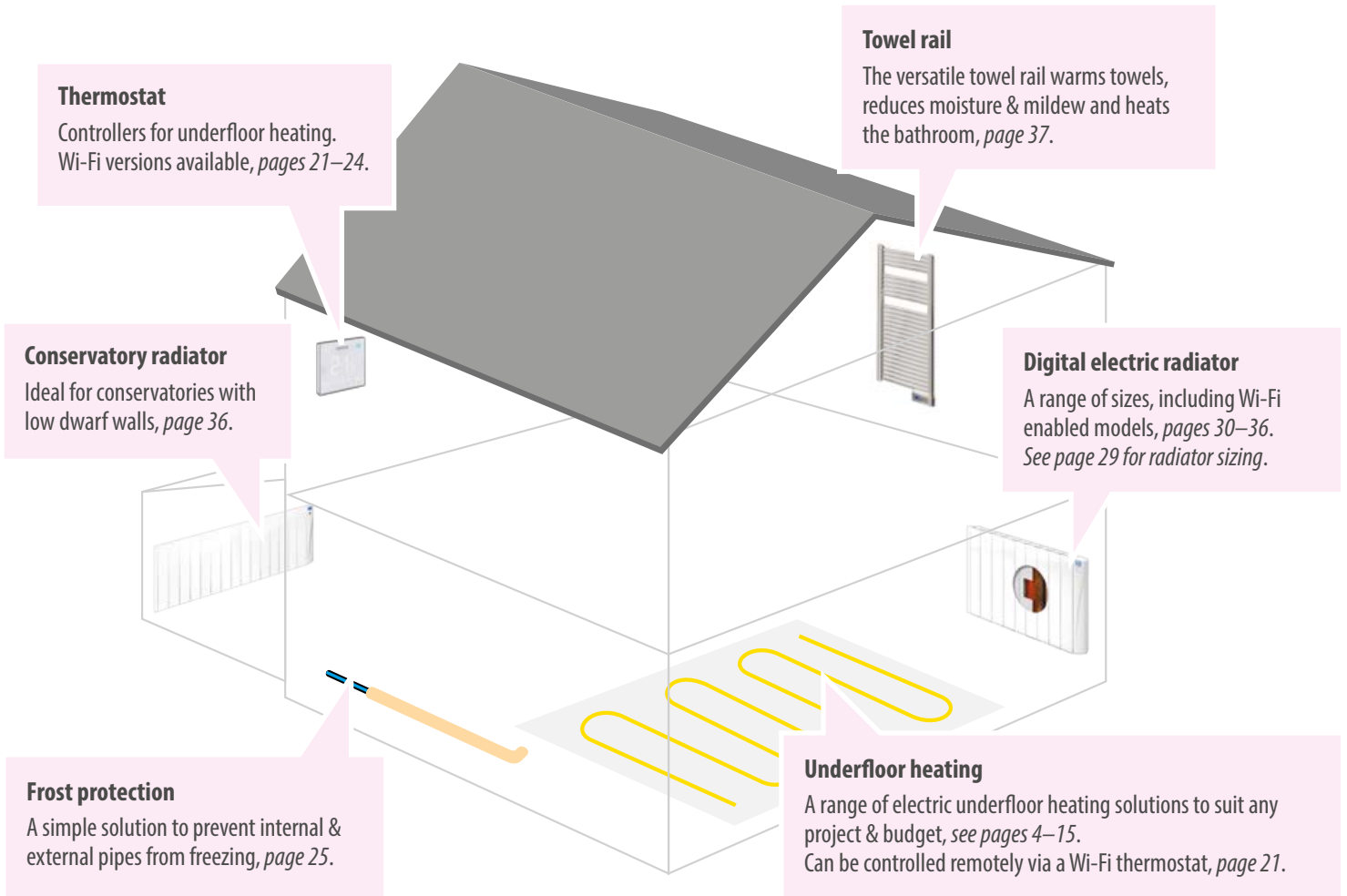

## With you every step of the way

We offer a range of heating products, but how do you know which one is best for your requirements?

Whether you're looking at heating options for a new build, a refurbishment, a new extension or simply reviewing your existing heating, we offer a comprehensive design service and can help you choose the best heating solution for your entire house.

With our Wi-Fi enabled radiators and thermostats, we are able to design a smart connected heating system that you can control from your smart device, anywhere at any time.

Our team have a wealth of heating experience and can guide you through all the technical details – we can even liaise with your architect, builder or electrician – so you don't have to worry.

Some of the benefits of using our free design service:

- Full service from start to finish
- Expert advice from a qualified team
- Free bespoke design service
- Free heat loss calculation
- Best value quality heating products

Contact us for more information

**01473 276677**

[sales@elementunderfloorheating.co.uk](mailto:sales@elementunderfloorheating.co.uk)

## Calculate your room size

1. If the ceiling height is less than 3 metres calculate the room size using metres squared ( $m^2$ ), otherwise use metres cubed ( $m^3$ ) if the ceiling height is more than 3 metres.
2. Refer to the map of the UK and note the colour in your area. The coolest parts are coloured dark blue and warmest parts are orange.
3. Look up the relevant sizing table below to find the correctly sized radiator for your room.

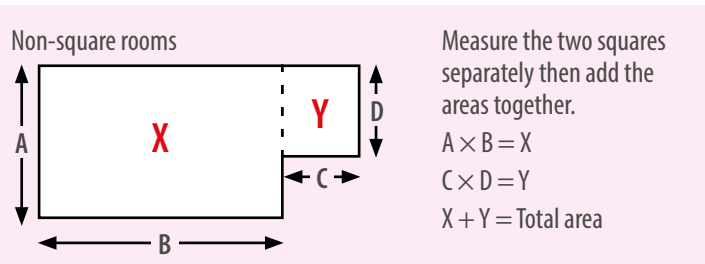
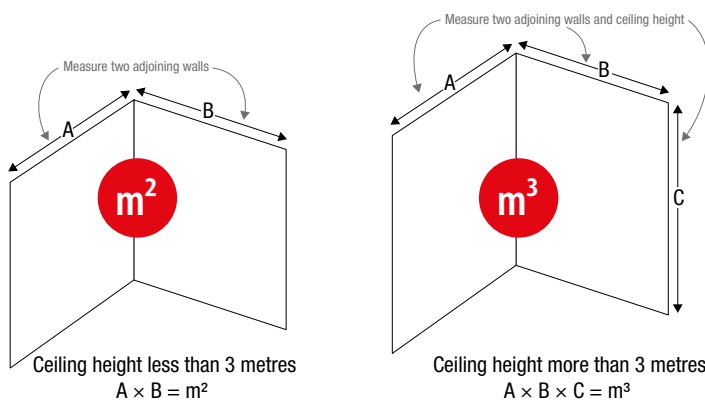

## Harmoni radiator sizing tables

Calculation  $m^2$  – ceiling height less than 3 metres

3 elements	Up to $4m^2$	Up to $4m^2$	Up to $3m^2$	Up to $2m^2$
4 elements	Up to $5m^2$	Up to $5m^2$	Up to $4m^2$	Up to $3m^2$
6 elements	Up to $8m^2$	Up to $7m^2$	Up to $7m^2$	Up to $6m^2$
8 elements	Up to $10m^2$	Up to $10m^2$	Up to $9m^2$	Up to $8m^2$
9 elements	Up to $11m^2$	Up to $11m^2$	Up to $10m^2$	Up to $9m^2$
10 elements	Up to $13m^2$	Up to $12m^2$	Up to $11m^2$	Up to $11m^2$
12 elements	Up to $16m^2$	Up to $15m^2$	Up to $14m^2$	Up to $13m^2$
14 elements	Up to $18m^2$	Up to $17m^2$	Up to $16m^2$	Up to $15m^2$

## Harmoni conservatory sizing tables

Calculation  $m^2$  – ceiling height less than 3 metres

11 elements	Up to $9m^2$	Up to $8m^2$	Up to $7m^2$	Up to $7m^2$
13 elements	Up to $10m^2$	Up to $9m^2$	Up to $9m^2$	Up to $8m^2$
15 elements	Up to $12m^2$	Up to $11m^2$	Up to $10m^2$	Up to $9m^2$

# Radiator Sizing

SIZING CHARTS FOR HARMONI RADIATORS

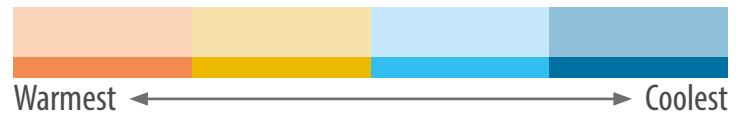
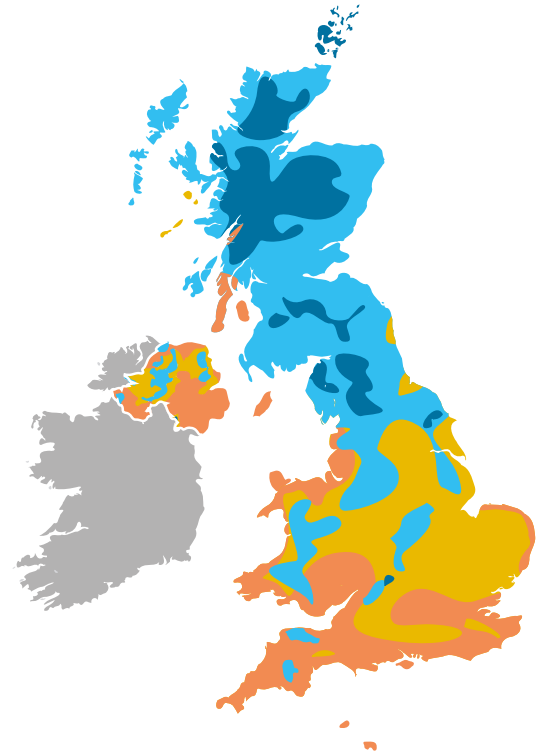

For a more accurate heat loss calculation, call us on 01473 276677

Calculation  $m^3$  – ceiling height more than 3 metres

3 elements	Up to $13m^3$	Up to $11m^3$	Up to $10m^3$	Up to $9m^3$
4 elements	Up to $17m^3$	Up to $15m^3$	Up to $13m^3$	Up to $12m^3$
6 elements	Up to $26m^3$	Up to $23m^3$	Up to $20m^3$	Up to $18m^3$
8 elements	Up to $34m^3$	Up to $30m^3$	Up to $26m^3$	Up to $24m^3$
9 elements	Up to $40m^3$	Up to $34m^3$	Up to $30m^3$	Up to $25m^3$
10 elements	Up to $43m^3$	Up to $38m^3$	Up to $33m^3$	Up to $30m^3$
12 elements	Up to $52m^3$	Up to $46m^3$	Up to $40m^3$	Up to $36m^3$
14 elements	Up to $60m^3$	Up to $54m^3$	Up to $48m^3$	Up to $42m^3$

Calculation  $m^3$  – ceiling height more than 3 metres

11 elements	Up to $27m^3$	Up to $24m^3$	Up to $21m^3$	Up to $19m^3$
13 elements	Up to $32m^3$	Up to $28m^3$	Up to $25m^3$	Up to $22m^3$
15 elements	Up to $37m^3$	Up to $32m^3$	Up to $29m^3$	Up to $26m^3$

# Harmoni Radiators

DIGITAL RADIATORS CONTROLLABLE  
VIA WI-FI & THE HARMONI APP

harmoni lugo<sup>+</sup>



**ALSO AVAILABLE:**

Conservatory radiators for low-level walls, see page 36

The premium range of Harmoni Lugo<sup>+</sup> electric radiators includes integrated Wi-Fi, a touch control panel with a high gloss finish, energy saving features and more. Using the Harmoni App, this intelligent radiator can be controlled from a smartphone, anytime and anywhere. The user can also view consumption and cost statistics – see page 38 for details of the Harmoni App. The Lugo<sup>+</sup> is available in six sizes ranging from 4–14 elements. Harmoni Lugo Touch is a non Wi-Fi version, see page 34.

## Features

- Integrated Wi-Fi for total control from a smartphone
- Highly accurate electronic thermostat
- 100% aluminium body
- Energy saving functions & eco mode

## Specification

Current	from 1.9A to 7A
Voltage	230V
Effective power	40% = 44W per element
Heat conductor	100% biodegradable thermal fluid

## Harmoni Lugo<sup>+</sup>

Q/F	Part Code	Description	Heats Rooms Up To	Wi-Fi Compatible	Dimensions (Length × Height × Depth)	List Price
16109	LUGOPLUSHS0440	Harmoni Lugo+ HS0440 4 Element 440W Electric Radiator (Wi-Fi)	4.5 m <sup>2</sup>	Yes	425 × 575 × 98 mm	£312.12
16110	LUGOPLUSHS0660	Harmoni Lugo+ HS0660 6 Element 660W Electric Radiator (Wi-Fi)	6.5 m <sup>2</sup>	Yes	585 × 575 × 98 mm	£392.71
16111	LUGOPLUSHS0880	Harmoni Lugo+ HS0880 8 Element 880W Electric Radiator (Wi-Fi)	9 m <sup>2</sup>	Yes	747 × 575 × 98 mm	£467.16
16112	LUGOPLUSHS1100	Harmoni Lugo+ HS1100 10 Element 1100W Electric Radiator (Wi-Fi)	11 m <sup>2</sup>	Yes	907 × 575 × 98 mm	£525.31
16113	LUGOPLUSHS1320	Harmoni Lugo+ HS1320 12 Element 1320W Electric Radiator (Wi-Fi)	13.5 m <sup>2</sup>	Yes	1069 × 575 × 98 mm	£582.42
16114	LUGOPLUSHS1540	Harmoni Lugo+ HS1540 14 Element 1540W Electric Radiator (Wi-Fi)	15.5 m <sup>2</sup>	Yes	1230 × 575 × 98 mm	£646.68

Contact us for more information

**01473 276677**

[sales@elementunderfloorheating.co.uk](mailto:sales@elementunderfloorheating.co.uk)









Best Price Guarantee



FREE Next Day Delivery







Expert Technical Advice

		
TFT display with energy consumption indicator.	Touch control panel with high gloss finish.	Energy saving functions: "Open Windows".
		
Programming 24 hours a day, 7 days a week.	3 working modes: Anti-frost, Eco and Comfort.	High precision electronic thermostat.



		
	Multi-platform control app for smartphone, tablet or PC.	4 editable pre-installed programs (A1, A2, A3 & A4).
		
	View consumption and REAL heating cost anytime, anywhere.	Simple pairing without gateways or additional configuration.

		
Built-in Wi-Fi module integrated into electronics.	Built-in consumption meter.	Aluminium body & fire retardant PC / ABS closures.
		
Mineral high heat transfer thermal fluid.	10 years guarantee on the aluminium.	2 years guarantee on the electronic components.

The Harmoni Lugo+ has built-in Wi-Fi and can be controlled using a smart device from anywhere, at anytime with the Harmoni App. *See page 38 for more details about the Harmoni App.*

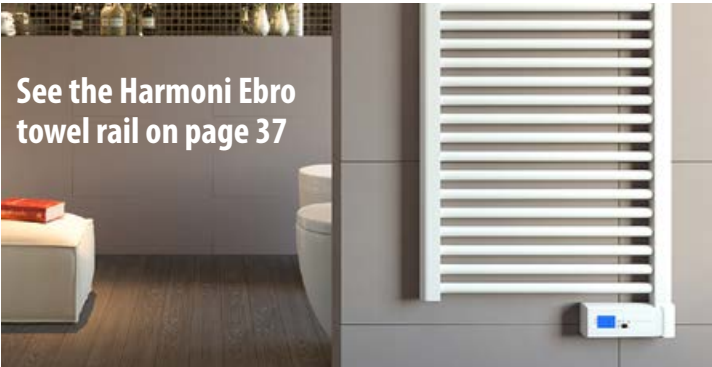

See the Harmoni Ebro towel rail on page 37

## FREE heat loss calculation



We offer a free electric heater room calculation. Just supply some details and dimensions of any room(s) that need heaters installed and we'll work out the size and quantity of Harmoni electric radiators required to establish and maintain a temperature of 21°C.

Call us on 01473 276677 for more details

# Harmoni Radiators

CERAMIC CORE DIGITAL RADIATORS  
CONTROLLABLE VIA WI-FI  
& THE HARMONI APP

harmoni duero<sup>+</sup>



The Wi-Fi enabled Duero<sup>+</sup> is incredibly quiet and its clay core ensures a comforting heating solution. A premium electric heating radiator boasting many features: a highly accurate thermostat, energy saving functions, eco mode, intelligent 24/7 programming control and more. Available in three different sizes. *See page 38 for details of the Harmoni App.*

## Features

- Integrated Wi-Fi for total control from a smartphone
- Energy saving functions including 'Open window' technology & eco mode
- 100% aluminium body
- Ceramic Core with built in thermostatic control ( $\pm 0.25$ )

## Specification

Current	from 1.9A to 7A
Voltage	230V
Effective power	40% = 44W per element
Thermal technology	Ceramic Core

## Harmoni Duero<sup>+</sup>

Q/F	Part Code	Description	Heats Rooms Up To	Wi-Fi Compatible	Dimensions (Length × Height × Depth)	List Price
16431	DUEROHDP500	Harmoni Duero+ HDP500 3 Element 500W Electric Radiator (Wi-Fi)	4.5 m <sup>2</sup>	Yes	345 × 575 × 98mm	£439.20
16432	DUEROHDP1000	Harmoni Duero+ HDP1000 6 Element 1000W Electric Radiator (Wi-Fi)	10 m <sup>2</sup>	Yes	585 × 575 × 98mm	£484.80
16433	DUEROHDP1500	Harmoni Duero+ HDP1500 9 Element 1500W Electric Radiator (Wi-Fi)	15 m <sup>2</sup>	Yes	827 × 575 × 98mm	£528.00

Contact us for more information

**01473 276677**

[sales@elementunderfloorheating.co.uk](mailto:sales@elementunderfloorheating.co.uk)



Best Price Guarantee



FREE Next Day Delivery



Expert Technical Advice



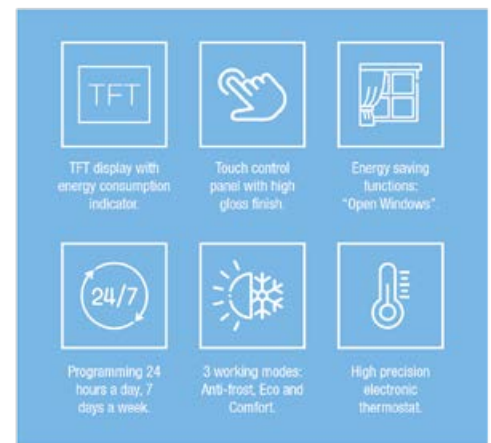
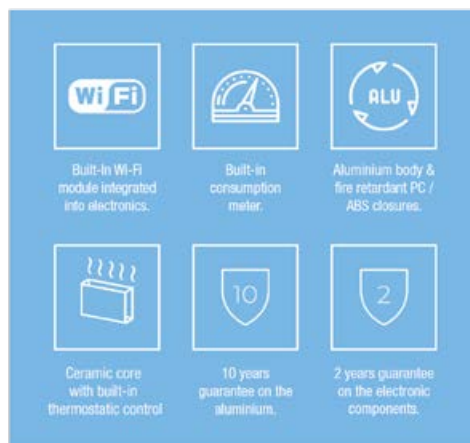
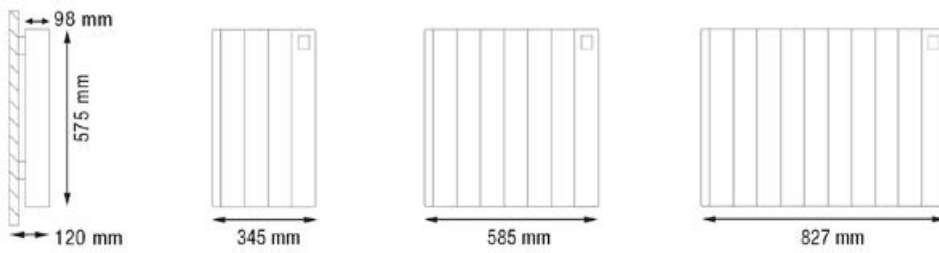

The Harmoni Duero+ has built-in Wi-Fi and can be controlled using a smart device from anywhere, at anytime with the Harmoni App. *See page 38 for more details about the Harmoni App.*

The advanced Duero+ range of radiators can be controlled using a smart device via the Harmoni App. The app gives you complete control over your heating system wherever and whenever you choose.

The Duero's clay core is excellent for heat retention. Combined with its cutting-edge technology and energy-saving features, this is an efficient radiator which can lower your carbon footprint and energy consumption – and it looks good too.

The high-quality aluminium body is corrosion-resistant, backed up by a 10-year warranty.

The Harmoni Duero Touch is a non Wi-Fi version, *see page 35.*

## FREE heat loss calculation

We offer a free electric heater room calculation. Just supply some details and dimensions of any room(s) that need heaters installed and we'll work out the size and quantity of Harmoni electric radiators required to establish and maintain a temperature of 21°C.



**Call us on 01473 276677 for more details**

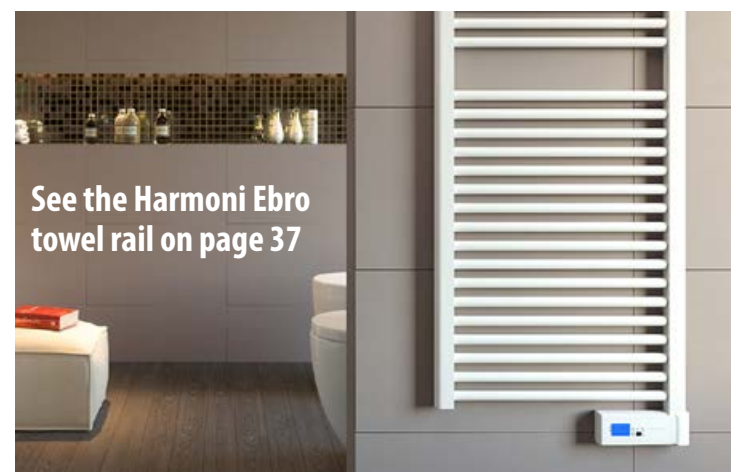

# Harmoni Radiators

ENERGY EFFICIENT, STYLISH  
DIGITAL RADIATORS

harmoni lugo touch



**ALSO AVAILABLE:**  
Conservatory radiators for low-level walls, see page 36

The Harmoni Lugo is a modern, beautifully designed low consumption digital radiator, manufactured from high quality materials. Built-in energy optimizing technology provides savings in power consumption compared with other technologies. The Lugo is available in six sizes ranging from 4–14 elements and can be programmed using an infrared remote control (optional extra) – see page 39.

## Features

- Highly accurate electronic thermostat
- Intelligent 24/7 programming control
- 100% aluminium body
- Energy saving functions & eco mode

## Specification

Current	from 1.9A to 7A
Voltage	230V
Effective power	40% = 44W per element
Heat conductor	100% biodegradable thermal fluid

## Harmoni Lugo Touch

Q/F	Part Code	Description	Heats Rooms Up To	Dimensions (Length × Height × Depth)	List Price
13455	LUGOHS0440T	Harmoni Lugo HS440 4 Element 440W Electric Radiator	4.5 m <sup>2</sup>	425 × 575 × 98 mm	£347.29
13456	LUGOHS0660T	Harmoni Lugo HS0660 6 Element 660W Electric Radiator	6.5 m <sup>2</sup>	585 × 575 × 98 mm	£437.65
13457	LUGOHS0880T	Harmoni Lugo HS0880 8 Element 880W Electric Radiator	9 m <sup>2</sup>	747 × 575 × 98 mm	£519.53
13458	LUGOHS1100T	Harmoni Lugo HS1100 10 Element 1100W Electric Radiator	11 m <sup>2</sup>	907 × 575 × 98 mm	£584.47
13459	LUGOHS1320T	Harmoni Lugo HS1320 12 Element 1320W Electric Radiator	13.5 m <sup>2</sup>	1069 × 575 × 98 mm	£649.42
13460	LUGOHS1540T	Harmoni Lugo HS1540 14 Element 1540W Electric Radiator	15.5 m <sup>2</sup>	1230 × 575 × 98 mm	£714.35

Contact us for more information

**01473 276677**

[sales@elementsunderfloorheating.co.uk](mailto:sales@elementsunderfloorheating.co.uk)



Best Price Guarantee



FREE Next Day Delivery



Expert Technical Advice

# Harmoni Radiators

CERAMIC CORE ENERGY  
EFFICIENT DIGITAL RADIATORS

harmoni duero touch



The Harmoni Duero is incredibly quiet and its clay core ensures a comforting heating solution. A premium electric heating radiator boasting many features: a highly accurate thermostat, energy saving functions, eco mode, intelligent 24/7 programming control and more. Available in 3 different sizes and can be programmed using an infrared remote control (optional extra) – see page 39.

## Features

- Bright blue screen with energy consumption indicator
- Intelligent 24/7 programming control
- Ceramic Core with built in thermostatic control ( $\pm 0.25$ )
- High purity aluminium body with polycarbonate closures PC/ABS

## Specification

Current	from 1.9A to 7A
Voltage	230V
Effective power	40% = 44W per element
Thermal technology	Ceramic core

## Harmoni Duero

Q/F	Part Code	Description	Heats Rooms Up To	Dimensions (Length x Height x Depth)	List Price
16428	DUEROHD500	Harmoni Duero HD500 3 Element 500W Clay Core Electric Radiator	4.5 m <sup>2</sup>	353 x 575 x 98 mm	£398.11
16429	DUEROHD1000	Harmoni Duero HD1000 6 Element 1000W Clay Core Electric Radiator	10 m <sup>2</sup>	550 x 575 x 98 mm	£535.20
16430	DUEROHD1500	Harmoni Duero HD1500 9 Element 1500W Clay Core Electric Radiator	15 m <sup>2</sup>	747 x 575 x 98 mm	£672.25



## FREE heat loss calculation

We'll work out the size and quantity of Harmoni Lugo radiators required to establish and maintain a temperature of 21°C.

Call us on 01473 276677  
for more details



# Harmoni Radiators

ELECTRIC CONSERVATORY RADIATORS FOR LOW-LEVEL WALLS

harmoni lugo

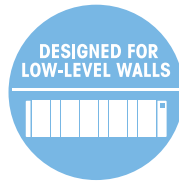
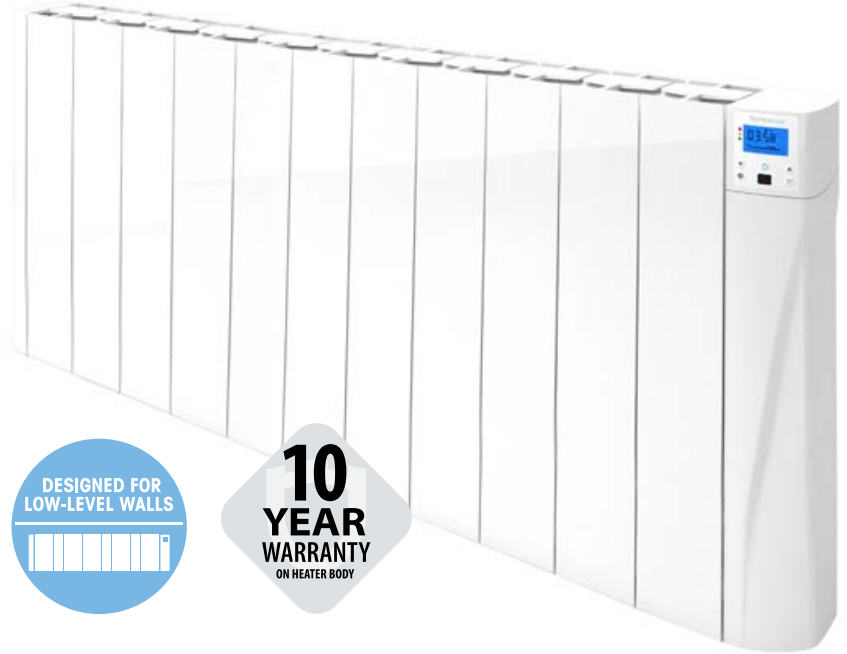

Perfect for conservatories or any rooms with low-level walls, the Harmoni Lugo is a high quality heating solution offering advanced efficiency and functionality. The Lugo's sensors will constantly monitor the conservatory and change the radiator's output appropriately to make sure the heat is always comfortable, as well as improving efficiency and performance. Available in three different sizes. Can be programmed using an infrared remote control (optional extra) – see page 39.

## Features

- Highly accurate electronic thermostat
- Intelligent 24/7 programming control
- Designed specifically for conservatories & low-level walls
- Energy saving functions & eco mode

## Specification

Height	420mm
Voltage	230V
Power per element	100W per element
Heat conductor	100% biodegradable thermal fluid

## Harmoni Lugo Conservatory Radiator

Q/F	Part Code	Description	Heats Rooms Up To	Dimensions (Length × Height × Depth)	List Price
13737	LUGOHSC1100T	Harmoni Lugo 11 Element 1100W Conservatory Electric Radiator	8 m <sup>2</sup>	1010 × 420 × 98 mm	£439.20
13738	LUGOHSC1300T	Harmoni Lugo 13 Element 1300W Conservatory Electric Radiator	10 m <sup>2</sup>	1180 × 420 × 98 mm	£484.80
13739	LUGOHSC1500T	Harmoni Lugo 15 Element 1500W Conservatory Electric Radiator	12 m <sup>2</sup>	1330 × 420 × 98 mm	£528.00

## Harmoni Lugo+ Conservatory Radiator

Q/F	Part Code	Description	Heats Rooms Up To	Dimensions (Length × Height × Depth)	List Price
18389	LUGOPHSC1100	Harmoni Lugo 11 Element 1100W Conservatory Electric Radiator	8 m <sup>2</sup>	1010 × 420 × 98 mm	£474.00
18390	LUGOPHSC1300	Harmoni Lugo 13 Element 1300W Conservatory Electric Radiator	10 m <sup>2</sup>	1180 × 420 × 98 mm	£532.84
18391	LUGOPHSC1500	Harmoni Lugo 15 Element 1500W Conservatory Electric Radiator	12 m <sup>2</sup>	1330 × 420 × 98 mm	£580.80



Available finishes



WHITE



CHROME



harmoni ebro

# Harmoni Towel Rails

ADD STYLE & WARMTH TO YOUR BATHROOM

The Ebro towel rail is the perfect solution to keep towels and the bathroom warm. Stylish and efficient, the Ebro is engineered to the highest standards. It boasts a unique boost function that enables the towel rail to operate at maximum power for two hours. The internal thermal fluid provides optimum heat transfer. Available in white and chrome finishes. Four different sizes available. Can be programmed using an infrared remote control (optional extra) – see page 39.

## Features

- Highly accurate electronic thermostat
- Intelligent 24/7 programming control
- Easy to follow settings and programming
- Premium quality construction

## Specification

Element	Armoured steel
Voltage	230V
Heat conductor	100% biodegradable thermal fluid
Protection rating	IP44

## Harmoni Ebro

White electric towel rails					
Q/F	Part Code	Description	Finish	Dimensions	List Price
13461	EBROHS030B	Harmoni Ebro HS030B 300W White Electric Towel Rail	White	500 × 800 × 50 mm	£223.20
13462	EBROHS050B	Harmoni Ebro HS050B 500W White Electric Towel Rail	White	500 × 1200 × 50 mm	£283.20
13463	EBROHS075B	Harmoni Ebro HS075B 750W White Electric Towel Rail	White	500 × 1600 × 50 mm	£321.60
13464	EBROHS100B	Harmoni Ebro HS100B 1000W White Electric Towel Rail	White	500 × 1800 × 50 mm	£352.80
Chrome electric towel rails					
13465	EBROHS030C	Harmoni Ebro HS030C 300W Chrome Electric Towel Rail	Chrome	500 × 800 × 50 mm	£355.20
13466	EBROHS50C	Harmoni Ebro HS050C 300W Chrome Electric Towel Rail	Chrome	500 × 1200 × 50 mm	£458.40
13467	EBROHS075C	Harmoni Ebro HS075C 500W Chrome Electric Towel Rail	Chrome	500 × 1600 × 50 mm	£571.20
13468	EBROHS100C	Harmoni Ebro HS100C 750W Chrome Electric Towel Rail	Chrome	500 × 1800 × 50 mm	£614.40

## Harmoni Remote Controller

The remote controller is compatible with the Harmoni range of radiators & towel rails. See page 35 for more details.

Q/F	Part Code	Description	Transmission range	Dimensions	List Price
13469	HSBC21	Harmoni HSBC21 Electric Heater Remote Controller	3 metres	58 × 155 × 16 mm	£91.20



# Harmoni App

COMPLETE CONTROL IN THE PALM OF YOUR HAND

harmoni app

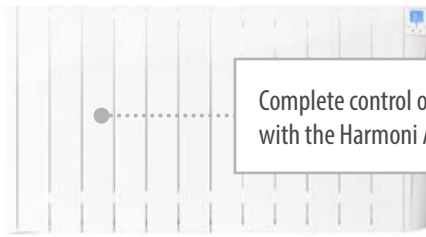

Complete control of the Harmoni Plus range with the Harmoni App



The Harmoni App allows the user complete control of all Harmoni Plus radiators from any smartphone, tablet or PC. Adjust temperatures, easily program and administer all the advanced functions of the Plus range from anywhere, at any time. Additionally, the user can view statistics, check and manage consumption. The Harmoni App is free to download from Apple or Google Play stores – search 'Harmoni App'. See page 30 for details of the Lugo+ & page 32 for the Duero+.

## Screen Descriptions

### Easy pairing tutorial

Simple tutorial to guide the user through the process of pairing their products with a smartphone via the Wi-Fi network.



### Main screen

This screen shows the status of the zones and the temperatures established in each one of them.

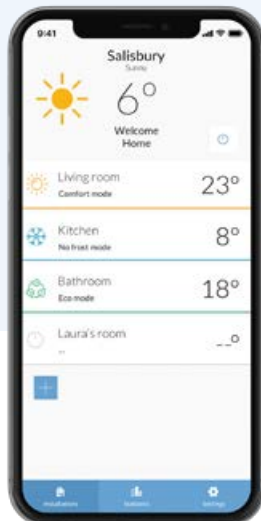

### Energy & consumption statistics

Quickly see and control the hours of use and the power consumed by the Harmoni heating system.



### Temperature control

The temperature of the products is controlled from an intuitive and easy to operate screen.



# Harmoni Remote Controller

SEND & RECEIVE PROGRAMMES  
BETWEEN TOWEL RAILS



## Features

- 4 different pre-installed programs
- 24/7 programming control
- Total control from one device
- Remote memory lock
- Manual / Automatic function
- CE & ROHS Applicable Regulations

The Harmoni infrared remote controller is compatible with all Ebro towel rails. Bi-directional wireless connection enables programming that, once sent to the product, can be received and copied into another product. The controller sports an ergonomic design with well-defined buttons, making it an easy-to-use device for everyone.

## Harmoni Remote Controller

Q/F	Part Code	Description	Transmission range	Dimensions	List Price
13469	HSBC21	Harmoni HSBC21 Electric Heater Remote Controller	3 metres	58 × 155 × 16 mm	£91.20



